

## NTSC/PAL Y/C/Jungle

**Description**

The CXA1871S is a bipolar IC which integrates the NTSC and PAL color TV luminance signal processing, chroma signal processing, sync signal processing, and RGB signal processing onto a single chip.

**Features**

- I<sup>2</sup>C bus compatible. Various types of adjustments and user controls performed with two bus lines SCL and SDA.
- H and V oscillation frequencies made non-adjusting with a countdown system.
- Non-adjusting Y system filters (chroma trap, delay line)
- Built-in V picture distortion correction circuit
- Built-in delay line aperture compensation
- Auto cut-off function for automatic CRT cut-off adjustment and compensation for changes with time
- Multiple inputs
  - Composite Video      2 systems  
(Built-in 2-input, 1-output video switch)
  - Y/C separation input: 1 system
  - On screen display input: 1 system
- Multiple system configuration possible using a non-adjusting SECAM chroma decoder.

**Applications**

Color TV

**Structure**

Bipolar silicon monolithic IC

48 pin SDIP (Plastic)

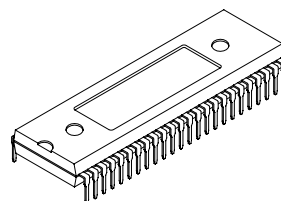
**Absolute Maximum Ratings** (Ta=25 °C)

- |                               |                  |             |    |
|-------------------------------|------------------|-------------|----|
| • Supply voltage              | V <sub>CC</sub>  | 12          | V  |
| • Operating temperature       | T <sub>opr</sub> | -20 to +75  | °C |
| • Storage temperature         | T <sub>stg</sub> | -65 to +150 | °C |
| • Allowable power dissipation | P <sub>D</sub>   | 1.8         | W  |

**Operating Conditions**

- |                |                 |       |   |
|----------------|-----------------|-------|---|
| Supply voltage | V <sub>CC</sub> | 9±0.5 | V |
|----------------|-----------------|-------|---|

Sony reserves the right to change products and specifications without prior notice. This information does not convey any license by any implication or otherwise under any patents or other right. Application circuits shown, if any, are typical examples illustrating the operation of the devices. Sony cannot assume responsibility for any problems arising out of the use of these circuits.

Block Diagram

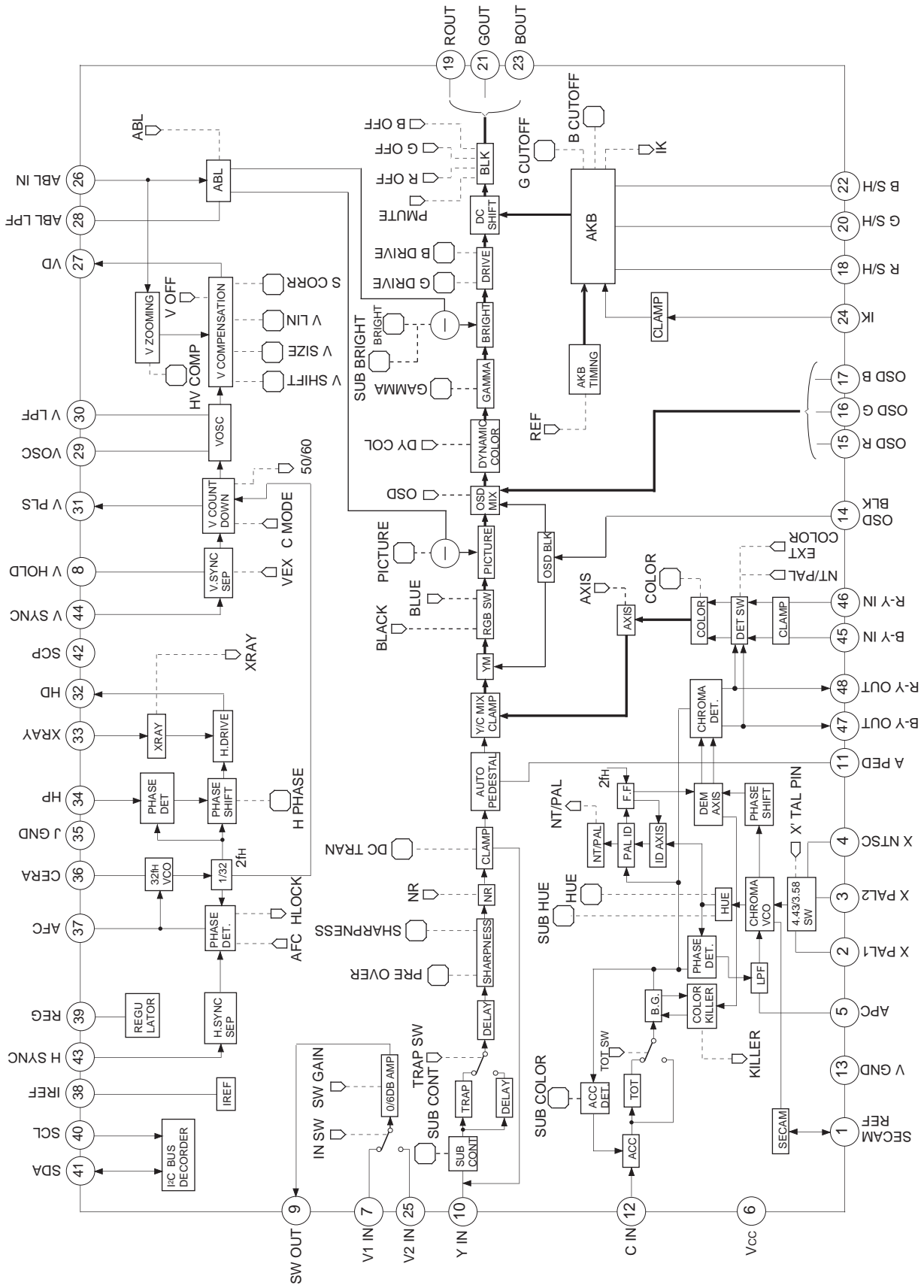

Pin Configuration

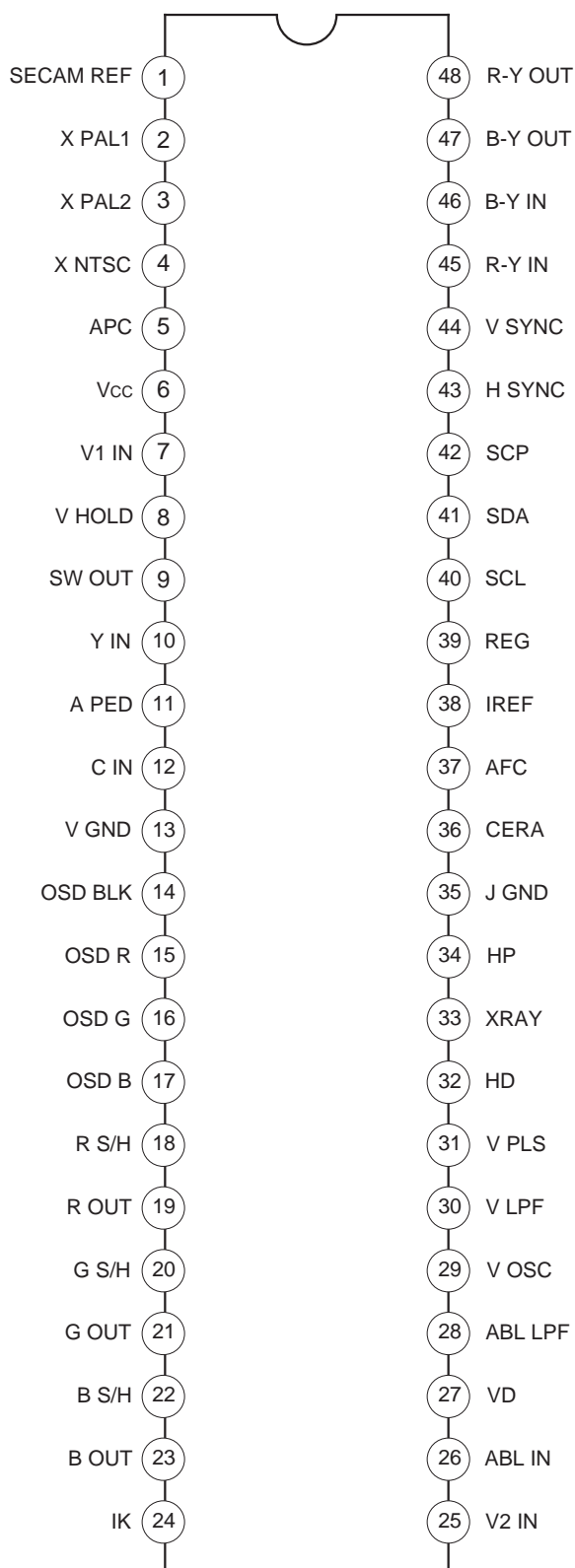

Pin Description

Pin No.	Symbol	Pin voltage	Equivalent circuit	Description
1	SECAM REF	1.3 V		When the IC is in the SECAM identification mode, the 4.43 MHz VCO oscillation waveform is output from this pin only during the VBLK period centering on DC = 1 V. If current of 150 $\mu$ A is led from this pin during this identification mode, the IC switches to the SECAM mode. In the SECAM mode, DC = 5 V.
2 3 4	X PAL 1 X PAL 2 X NTSC	2.6 V		Crystal oscillator connection pins. Connect the PAL/N and 4.43 MHz crystals to Pin 2, the PAL/M crystal to Pin 3, and the NTSC crystal to Pin 4.
5	APC	5 V		APC lag-lead filter CR connection pin.
6	Vcc	9 V		Power supply pin.
7 25	V1 IN V2 IN	2 V		Video switch input pins. Sync tip clamping is performed, so input via capacitors.

Pin No.	Symbol	Pin voltage	Equivalent circuit	Description
8	V HOLD	0.7 V		Peak hold pin for V sync separation. Connect a capacitor.
9	SW OUT	—		Video switch output pin.
10	Y IN	3.5 V		Y signal input pin. Input via a capacitor. Standard input level: 2 Vp-p
11	A PED	3.5 V		Auto pedestal (black stretch) black peak hold pin. Connect a capacitor.

Pin No.	Symbol	Pin voltage	Equivalent circuit	Description
12	C IN	—		<p>Chroma signal input pin.</p> <p>Standard input level (burst level) : 570 mVp-p</p>
13	V GND	—		Video system (Y/C/RGB) GND pin.
14	OSD BLK	—		<p>Blanking signal input pin for OSD RGB input.</p> <p>0 to 1 V: Blanking not performed. 2 to 3 V: Signal from Y IN/C IN lowered by -6 dB. 4 to 6 V: R, G and B outputs become lower than black level.</p>
15 16 17	OSD R OSD G OSD B	—		<p>Digital R, G and B signal input pins for on screen display.</p> <p>0 to 1 V: No OSD display. 2 to 3 V: OSD level 49 IRE (34 IRE) 4 to 6 V: OSD level 96 IRE (67 IRE) Figures in parentheses are for when the I<sup>2</sup>C OSD register is set to 0.</p>
18 20 22	R S/H G S/H B S/H	—		<p>Sample-and-hold pins for R, G and B AKB (Auto Kinetic Bias). Connect to GND via capacitors.</p>

Pin No.	Symbol	Pin voltage	Equivalent circuit	Description
19 21 23	R OUT G OUT B OUT	—		R, G and B output pins.
24	IK	—		Inputs the signal obtained by converting the CRT beam current (IK) into voltage. Connect to an emitter follower via a capacitor.
26	ABL IN	—		ABL voltage input pin.
27	VD	—		Vertical deflection sawtooth wave output pin.
28	ABL LPF	—		ABL signal LPF pin. Connect a capacitor. If the AKB loop is unstable when the power is turned on, this pin is lowered to around 0.3 V.

Pin No.	Symbol	Pin voltage	Equivalent circuit	Description
29	V OSC	—		Connect a capacitor to generate the V sawtooth wave.
30	V LPF	5 V		Connect a capacitor to hold the AGC voltage which maintains the V sawtooth wave at a constant amplitude.
31	V PLS	—		V pulse output pin. A negative polarity pulse 3 to 3.5 H width is output from this pin.  High level: 4.5 V Low level: 0 V
32	HD	—		H drive output pin. This pin is output at the open collector.
33	XRAY	—		X-ray protection circuit input pin. When a pulse with a width of 7 V or more is input, HD output becomes low and R, G and B outputs are blanked. This status is maintained until the power supply is turned off.  Vilmax = 2.4 V Vihmin = 3.0 V



Pin No.	Symbol	Pin voltage	Equivalent circuit	Description
34	HP	3.3 V (at no signal)		H pulse input pin. Inputs a 3 to 5 Vp-p signal via a capacitor.
35	J GND	—		Jungle system (H/V) GND pin.
36	CERA	2.3 V		Connect a 32 fh (503.5 kHz) ceramic oscillator.
37	AFC	3.2 V		AFC lag-lead filter CR connection pin.
38	IREF	2.6 V		Connect a 15 kΩ resistor between this pin and GND.

Pin No.	Symbol	Pin voltage	Equivalent circuit	Description
39	REG	7 V		Regulator pin for voltage generated internally from Vcc. Connect a capacitor for stabilization.
40 41	SCL SDA	—		I <sup>2</sup> C bus SCL (Serial Clock) and SDA (Serial Data) pins.  V <sub>ilmax</sub> = 1.5 V V <sub>ihmin</sub> = 3 V V <sub>olmax</sub> = 0.4 V
42	SCP	—		Outputs BGP, HBLK and VBLK as SCP (Sand Cathle Pulse). The Typ. waveform is as follows.
43	H SYNC	2.6 V		H sync separation input pin. Inputs a 2 V <sub>p-p</sub> video signal via a capacitor and resistor.
44	V SYNC	3.8 V		V sync separation input pin. Inputs a 2 V <sub>p-p</sub> video signal via a capacitor and resistor.

Pin No.	Symbol	Pin voltage	Equivalent circuit	Description
45 46	R-Y IN B-Y IN	5.2 V		<p>Color difference signal input pins. Input via capacitors.</p> <p>Standard input level B-Y: 1.33 Vp-p R-Y: 1.05 Vp-p</p>
47 48	B-Y OUT R-Y OUT	5 V		<p>Color difference signal output pins.</p> <p>Standard input level B-Y: 0.665 Vp-p R-Y: 0.525 Vp-p</p>

**Electrical Characteristics**

Setting conditions

- Ta = 25 °C, Vcc = 9 V
- I<sup>2</sup>C bus register should be set to “I<sup>2</sup>C Bus Register Initial Settings”.

No.	Item	Symbol	Measurement conditions	Measurement pin	Measurement method	Min.	Typ.	Max.	Unit
1	Current consumption 1	ICC1		6	Measure the V <sub>cc</sub> pin inflow current.	70	105	140	mA

**H system items**

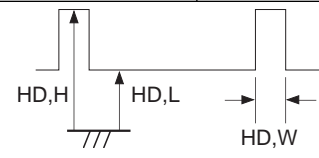
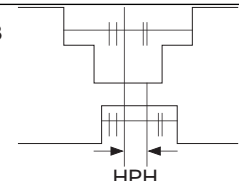
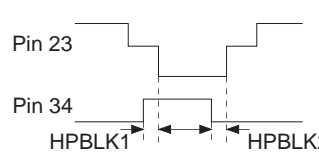
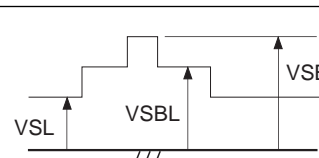
No.	Item	Symbol	Measurement conditions	Measurement pin	Measurement method	Min.	Typ.	Max.	Unit
2	Horizontal free running frequency	Hfree		32		15.47	15.65	15.83	kHz
3	Horizontal sync pull-in range	ΔH	Video In: Sig-H2,H3 AFC: 0		Check that I <sup>2</sup> C register HLOCK is 1.	-400	—	400	Hz
4	AFC gain 1	AFCmax	Video In: Sig-H6 AFC: 0 Video In: Sig-H7 AFC: 0	34	t1: Video In: Time from fall of Sig-H6 to rise of Pin 34.	0.12	0.30	0.48	μs
5	AFC gain 2	AFCcen	Video In: Sig-H6 AFC: 1 Video In: Sig-H7 AFC: 1	34	t2: Video In: Time from fall of Sig-H7 to rise of Pin 34.	—	0.5	—	μs
6	AFC gain 3	AFCmin	Video In: Sig-H6 AFC: 2 Video In: Sig-H7 AFC: 2	34		0.75	1.2	1.75	μs
7	HD output pulse width	HD, W	Video In: Sig-H1	32		24	26	28	μs
8	HD output high level	HD, H	Video In: Sig-H1			8.7	9	—	V
9	HD output low level	HD, L	Video In: Sig-H1			0.5	0.8	1.1	V
10	Horizontal phase operating range 1	HPHmax	Video In: Sig-Y1 HPHASE: F	23 34		-4.3	-3.3	-2.3	μs
11	Horizontal phase operating range 2	HPHcen	Video In: Sig-Y1 HPHASE: 7			-1.5	-0.5	0.5	μs
12	Horizontal phase operating range 3	HPHmin	Video In: Sig-Y1 HPHASE: 0			1.3	2.3	3.3	μs
13	HP blanking delay time 1	HPBLK1	Video In: Sig-Y1	23 34		—	100	—	ns
14	HP blanking delay time 2	HPBLK2				—	100	—	ns
15	SCP BGP output level	VSB		42		4	5.0	6	V
16	SCP BLK output level	VSBL				2.5	V		
17	SCP low level	VSL				0.3	V		
18	Oversvoltage protection circuit VTH	XVTH		32	Check that HD appears at 2.4 V and disappears at 2.8 V.	2.4	2.6	2.8	V

V system items

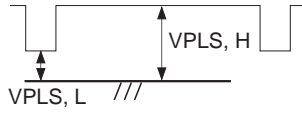
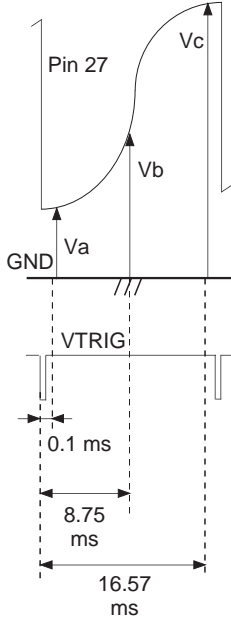
No.	Item	Symbol	Measurement conditions	Measurement pin	Measurement method	Min.	Typ.	Max.	Unit	
19	V PLS high level	VPLS, H	Video In:Sig-V1	31		4	4.5	5	V	
20	V PLS low level	VPLS, L				0	0.1	0.5	V	
21	VD output center voltage	VDcen	V SHIFT:F	27		Vb	2.75	2.9	3.05	V
22	V SHIFT variable range 1	VSHIFT-	V SHIFT:0			Vb-VDcen	-140	-125	-115	mV
23	V SHIFT variable range 2	VSHIFT+	V SHIFT:1F			Vb-VDcen	110	120	140	mV
24	V SIZE variable range 1	VSIZE-	V SIZE:0			Vc-Va	0.9	1.1	1.2	V
25	V SIZE variable range 2	VSIZE+	V SIZE:3F			Vc-Va	1.5	1.65	1.8	V
26	S CORR variable range 1	ΔSa	S CORR:0			Vsa=Va	45	65	85	mV
			S CORR:F			Vsc=Vc				
27	S CORR variable range 2	ΔSc	S CORR:F			Vc-Vsc	-55	-35	-15	mV
28	V LIN variable range 1	ΔLa	V LIN:0			Vla=Va	90	120	140	mV
			V LIN:F			Vlc=Vc				
29	V LIN variable range 2	ΔLc	V LIN:F	Va-Vla	60	90	110	mV		
30	V zooming 1	ΔVZ1	HV COMP: 0, Pin 26: 6 V	Vc-Vlc	60	90	110	mV		
			HV COMP: 7, Pin 26: 6 V	Vsmin=Vc-Va						
31	V zooming 2	ΔVZ2	HV COMP: 0, Pin 26: 0 V	Vsmax=Vc-Va	0	3	15	mV		
			HV COMP: 7, Pin 26: 0 V	Vsmin-(Vc-Va)						
31	V zooming 2	ΔVZ2	HV COMP: 7, Pin 26: 0 V	Vsmax-(Vc-Va)	60	80	100	mV		

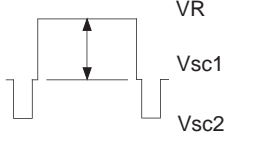
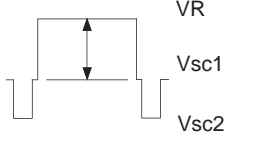
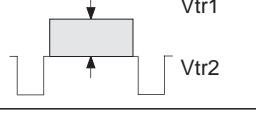
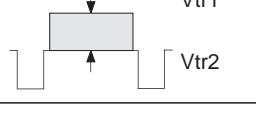
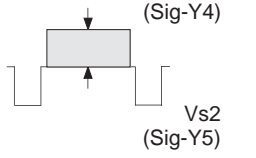
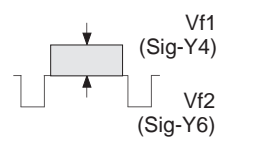
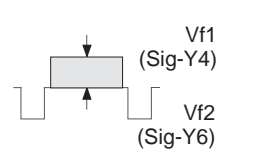
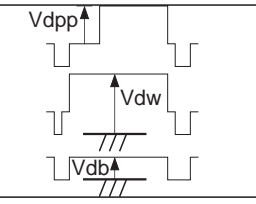
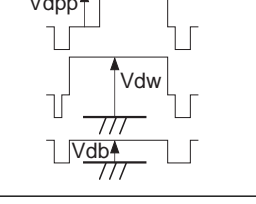
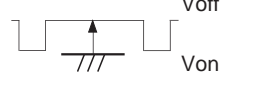
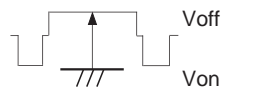

Y system items

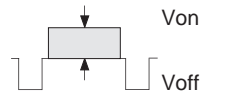
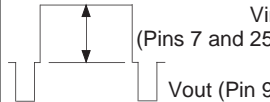
No.	Item	Symbol	Measurement conditions	Measurement pin	Measurement method	Min.	Typ.	Max.	Unit	
32	R output level	VR	Video In:Sig-Y1		 VR	—	2.5	—	V	
33	Sub-contrast variable range 1	Gsc, max	SUBCONT: F	19	 Vsc1 Vsc2	$20\log \frac{Vsc1}{VR}$	2.2	2.7	3.2	dB
34	Sub-contrast variable range 2	Gsc, min	SUBCONT: 0							
35	Trap attenuation 1	ATT trap1	TRAP SW: 0	19	 Vtr1 Vtr2	$20\log \frac{Vtr2}{Vtr1}$	—	-30	-20	dB
			TRAP SW: 1							
36	Trap attenuation 2	ATT trap2	TRAP SW: 0	19	 Vtr1 Vtr2	$20\log \frac{Vtr2}{Vtr1}$	—	-30	-20	dB
			TRAP SW: 1							
37	Sharpness characteristics 1	Gsh, max	SHARP NESS: F	19	 Vs1 (Sig-Y4) Vs2 (Sig-Y5)	$20\log \frac{Vs2}{Vs1}$	5.5	7.0	8.5	dB
38	Sharpness characteristics 2	Gsh, cen	SHARP NESS: 7				1.5	2.5	4.5	dB
39	Sharpness characteristics 3	Gsh, min	SHARP NESS: 0				-7.5	-5.5	-3.0	dB
40	RGB output frequency response 1	Gfreq1	DELAY=0	19 21 23	 Vf1 (Sig-Y4) Vf2 (Sig-Y6)	$20\log \frac{Vf2}{Vf1}$	-6	-3.0	0	dB
41	RGB output frequency response 2	Gfreq2	DELAY=2	19 21 23	 Vf1 (Sig-Y4) Vf2 (Sig-Y6)	$20\log \frac{Vf2}{Vf1}$	-7	-4.2	-1	dB
42	DC transmission rate 1	Gdt1	DC TRAN: 0	19	 Vdpp Vdw Vdb	$\frac{Vdw-Vdb}{Vdpp}$	96	99	100	%
				Video In: Sig-Y3 Video In: Sig-Y1 Video In: Sig-H1						
43	DC transmission rate 2	Gdt2	DC TRAN: 7	19	 Vdpp Vdw Vdb	$\frac{Vdw-Vdb}{Vdpp}$	73	78	85	%
				Video In: Sig-Y3 Video In: Sig-Y1 Video In: Sig-H1						
44	Auto pedestal operation 1	Vdp1	Pin 11: 3 V Pin 11: 5 V	19	 Voff Von	Voff-Von	280	340	400	mV
45	Auto pedestal operation 2	Vdp2	Pin 11: 3 V Pin 11: OPEN	19	 Voff Von	Voff-Von	80	130	170	mV

No.	Item	Symbol	Measurement conditions	Measurement pin	Measurement method	Min.	Typ.	Max.	Unit		
46	NR operation	Gnr	NR: 1	Video In: Sig-Y7	19		$20\log \frac{V_{on}}{V_{off}}$	-6	-4.5	-3	dB
			NR: 0								
47	SW gain 1	Gsw1	SW GAIN: 1	Video In: Sig-Y1	7, 25 9		$20\log \frac{V_{out}}{V_{in}}$	5.5	6	6.5	dB
48	SW gain 2	Gsw2	SW GAIN: 0					-0.5	0	0.5	dB

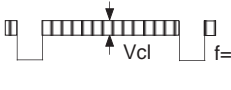
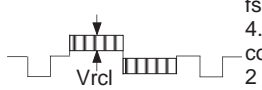
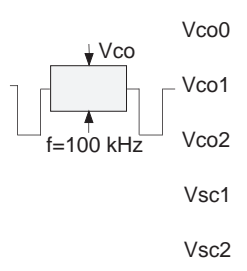
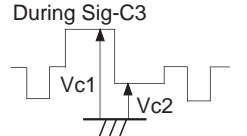
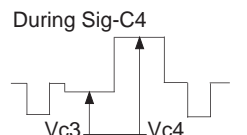
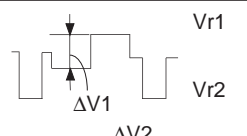
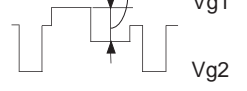
C system items

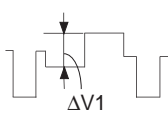
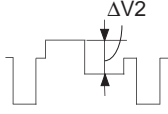
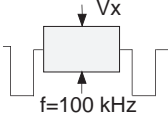
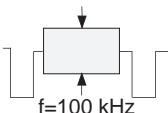
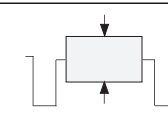
No.	Item	Symbol	Measurement conditions	Measurement pin	Measurement method	Min.	Typ.	Max.	Unit		
49	APC pull-in range 1	$\Delta f, apc1$	Video-In: Sig-H1 C In: Sig-C1, C2	23	Check that the burst frequency is changed to 3579545 $\pm$ 350 Hz and pulled in.	-350	—	350	Hz		
50	APC pull-in range 2	$\Delta f, apc2$	Video-In: Sig-H1 C In: Sig-C1, C2		Check that the burst frequency is changed to 4433619 $\pm$ 350 Hz and pulled in.	-350	—	350	Hz		
51	Carrier leak	Vcl	Video-In: Sig-H1 COLOR: 3F SUBCOLOR: F	23		—	—	50	mV		
52	Residual carrier level	Vrcl	Video-In: Sig-H1 C In: Sig-C3 COLOR: 3F SUBCOLOR: F			—	—	200	mV		
53	Color output level	Vco, cen		23		0.6	0.9	1.2	V		
54	Color variable range 1	Gco, max	COLOR: 3F			$20\log \frac{V_{co1}}{V_{co0}}$	5.6	6.3	6.9	dB	
55	Color variable range 2	Gco, min	COLOR: 0			$20\log \frac{V_{co2}}{V_{co0}}$	—	-50	-40	dB	
56	Sub-color variable range 1	Gsc, max	SUB COLOR : F			$20\log \frac{V_{sc1}}{V_{co0}}$	2.1	2.7	3.3	dB	
57	Sub-color variable range 2	Gsc, min	SUB COLOR : 0			$20\log \frac{V_{sc2}}{V_{co0}}$	-5.4	-3.7	-2.0	dB	
58	Hue variable range 1	$\phi_{cen}$		20	During Sig-C3 	-10	0	10	deg		
59	Hue variable range 2	$\phi_{max}$	HUE: 3F		$\tan^{-1} \frac{V_{c1}-V_{c2}}{V_{c4}-V_{c3}}$	During Sig-C4 	-54	-44	-34	deg	
60	Hue variable range 3	$\phi_{min}$	HUE: 0				23	33	43	deg	
61	Sub-hue variable range 1	$\phi_s, max$	SUB HUE: F				-21	-15	-9	deg	
62	Sub-hue variable range 2	$\phi_s, min$	SUB HUE:0				8	13	20	deg	
63	Detective axis R1	$\phi_{r1}$	AXIS: 0	Video In: Sig-H1, C In: Sig -C4 -C3	19		$90^{\circ}+$	105	112	119	deg
64	Detective axis G1	$\phi_{g1}$					$\tan^{-1} \frac{V_{r2}}{V_{r1}}$				
65	Detective output ratio R1	Gr1	AXIS: 0	Video In: Sig-H1, C In: Sig -C5	19		$\frac{V_x}{G_{comax}} \frac{VBW}{VRW}$	0.7	0.8	0.9	—
66	Detective output ratio G1	Gg1					$\frac{V_x}{G_{comax}} \frac{VBW}{VGW}$				

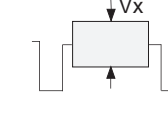
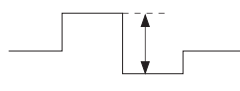
No.	Item	Symbol	Measurement conditions		Measurement pin	Measurement method		Min.	Typ.	Max.	Unit
67	Detective axis R2	$\phi r2$	AXIS: 1	Video In: Sig-H1, C In: Sig-C4, -C3	19		$90^{\circ}+$ $\tan^{-1} \frac{Vr2}{Vr1}$	83	90	97	deg
68	Detective axis G2	$\phi g2$			21		$270^{\circ}-$ $\tan^{-1} \frac{Vg2}{Vg1}$	229	236	243	deg
69	Detective output ratio R2	Gr2	AXIS: 1	Video In: Sig-H1 C In: Si -C5	19		$\frac{Vx}{Gcomax} \frac{VBW}{VRW}$	0.49	0.56	0.63	—
70	Detective output ratio G2	Gg2			20	$f=100 \text{ kHz}$		$\frac{Vx}{Gcomax} \frac{VBW}{VGW}$	0.29	0.34	0.39
71	AGC characteristics 1	Gacc1	Video In: Sig-H1	C In: Sig-C6,	20		$20 \log \frac{Vac1}{Vco0}$	-1.0	0.1	1.0	dB
72	AGC characteristics 2	Gacc2		C In: Sig-C7			$20 \log \frac{Vac2}{Vco0}$	-3	-1	0	dB
73	Killer point 1	KPNT	During NTSC input	Video In: Sig-H1	23		Check that output disappears at -38 dB and appears at -30 dB.	-38	-34	-30	dB
74	Killer point 2	KPPAL	During PAL input	C In: Sig-C8 -C9				-38	-34	-30	dB
75	Chroma frequency response 1-1	Gcf1-	TOT SW: 1 Video-In: Sig-H1	C In: Sig-C5 -C11	23		$20 \log \frac{Vx}{Vref}$  Vref= Vx (Sig-C5)	—	-3	—	dB
76	Chroma frequency response 1-2	Gcf1+	fsc =3.58 MHz	C In: Sig-C10				—	-1	—	dB
77	Chroma frequency response 2-1	Gcf2-	TOT SW: 0 Video-In: Sig-H1	C In: Sig-C5 -C11				-2.3	—	0.2	dB
78	Chroma frequency response 2-2	Gcf2+	fsc =3.58 MHz	C In: Sig-C10				-2.7	—	0.2	dB
79	Chroma frequency response 3-1	Gcf3-	TOT SW: 1 Video-In: Sig-H1	C In: Sig -C5 -C11				—	-3	—	dB
80	Chroma frequency response 3-2	Gcf3+	fsc =4.43 MHz	C In: Sig-C10				—	-1	—	dB
81	Chroma frequency response 4-1	Gcf4-	TOT SW: 0 Video-In: Sig-H1	C In: Sig-C5 -C11				-2.3	—	0.2	dB
82	Chroma frequency response 4-2	Gcf4+	fsc =4.43 MHz	C In: Sig-C10				-2.7	—	0.2	dB
83	R-Y output amplitude	VRY	Video-In: Sig-H1 C In: Sig-C13	48		—	0.5	—	Vp-p		
84	B-Y output amplitude	VBY	Video-In: Sig-H1 C In: Sig-C12	47		—	0.62	—	Vp-p		
85	Output amplitude ratio	VBR		—	VBR=VBY/VRY	—	1.26	—			

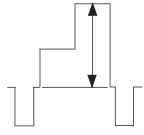
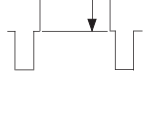
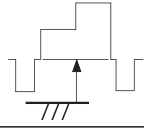
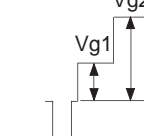
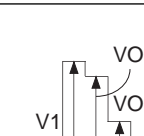
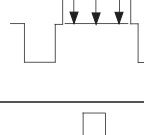
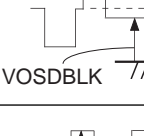
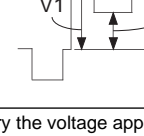
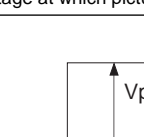
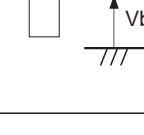

RGB system items

No.	Item	Symbol	Measurement conditions	Measurement pin	Measurement method	Min.	Typ.	Max.	Unit		
86	Drive variable range 1	Gdr1	G DRIVE: 1F B DRIVE: 1F	Video-In: Sig-H1		$20\log \frac{V_{dr1}}{V_{r0}}$	0.7	1.5	2.2	dB	
											19
87	Drive variable range 2	Gdr2	G DRIVE: 0 B DRIVE: 0	Y In: Sig-R1		$20\log \frac{V_{dr2}}{V_{r0}}$	-5.2	-4.5	-3.3	dB	
											21 23
88	Picture variable range	Gpic	PICTURE: 0	Video-In: Sig-H1		$20\log \frac{V_{r1}}{V_{r0}}$	-15.7	-14.7	-13.7	dB	
89	Dynamic color operation R	Gdy, r	DY COL: 0	Video-In: Sig-H1		$\frac{V_{dyr}}{V_{r0}} \times 100$	94.5	97	98.5	%	
90	Dynamic color operation B	Gdy, b		Y In: Sig-R1		$\frac{V_{dyb}}{V_{dr1}} \times 100$	103	105.5	107	%	
91	Gamma characteristics 1 (50 IRE)	GAM1	GAMMA: 0/7	Video-In: Sig-H1 Y In: Sig-R1		$\frac{V_{g1} \text{ (GAMMA: 7)}}{-V_{g1} \text{ (GAMMA: 0)}} \times 100$	10	18	26	IRE	
92	Gamma characteristics 2 (100 IRE)	GAM2				$\frac{V_{g2} \text{ (GAMMA: 7)}}{-V_{g2} \text{ (GAMMA: 0)}} \times 100$	-8	0	8	IRE	
93	OSD level 1	Vosd1	OSD: 0	Video-In: Sig-H1 OSD BLK: Sig-R3		$\frac{V_{OSD}}{V_1} \times 100$	55	65	75	IRE	
94	OSD level 2	Vosd2					23	33	43	IRE	
95	OSD level 3	Vosd3					OSD: 1	82	92	102	IRE
96	OSD level 4	Vosd4						36	46	56	IRE
97	OSD BLK black variation	$\Delta V_{osd}$	OSD BLK: Sig-R2 (5 V)	Video In: Sig-Y1		$V_D - V_{OSDBLK}$	-150	190	410	mV	
98	OSD BLK attenuation	Gosd	OSD BLK: Sig-R2 (3 V)	Video In: Sig-Y1		$20\log \frac{V_2}{V_1}$	-7	-6	-5	dB	
99	ABL threshold value	Vth, abl	Video In: Sig-Y1		19	Vary the voltage applied to Pin 26 and measure the voltage at which picture ABL operates		1.1	1.2	1.3	V
100	ABL gain	Gabl1	ABL: 3	Video In: Sig-Y1		$20\log \frac{V_p, 5 V}{V_p, 9 V}$	-3.4	-2.4	-1.4	dB	
101	ABL black level 1	Vabl1				$V_b, 5 V - V_b, 9 V$	140	240	340	mV	
102	ABL gain 2	Gabl2	ABL: 0	Pin 28: 9 V/5 V		$20\log \frac{V_p, 5 V}{V_p, 9 V}$	-8.8	-6.8	-4.8	dB	
103	ABL black level 2	Vabl2				$V_b, 5 V - V_b, 9 V$	-100	0	100	mV	
104	Blanking level	Vblk	Video In: Sig-R1		19 21 23	Measure the R, G and B blanking levels.		0	0.2	0.4	V

No.	Item	Symbol	Measurement conditions	Measurement pin	Measurement method	Min.	Typ.	Max.	Unit	
105	lk clamp level	Vlk, clp		Video In: Sig-V1 24		1.25	1.35	1.45	V	
106	lk R level	Vlk, r				0.76	0.86	0.96	V	
107	lk variable range 1	Vlk, max	G CUTOFF: F B CUTOFF: F			Vlk, b-Vlk, r	0.25	0.35	0.45	V
108	lk variable range 2	Vlk, min	G CUTOFF: 0 B CUTOFF: 0				-0.64	-0.54	-0.44	V
109	RGB output DC range 1	Vref, max	Vsh: 4.6 V (Pins 18, 20 and 22)	19 21 23	Vref	3.2	3.5	4.0	V	
110	RGB output DC range 2	Vref, min	Vsh: 8 V (Pins 18, 20 and 22)	0.45		0.85	1.25	V		
111	Bright center -R	Vbcen, r	BRIGHT: 1F	19	Vsig-Vref	-0.5	-0.4	-0.3	V	
112	Bright center -G, B	Vbcen, gb		21 23		-0.46	-0.36	-0.26	V	
113	Bright variable range 1-R	Vbprt1, r	BRIGHT: 3F	19		0.3	0.35	0.4	V	
114	Bright variable range 1-G, B	Vbprt1, gb		21 23		0.27	0.32	0.37	V	
115	Bright variable range 2-R	Vbprt2, r	BRIGHT: 0	19		-0.38	-0.33	-0.28	V	
116	Bright variable range 2-G, B	Vbprt2, gb		21 23		-0.36	-0.31	-0.26	V	
117	Sub-bright variable range 1-R	Vsbprt1, r	SUB BRIGHT: 3F	19		Vsig (BRIGHT: 1F) -Vsig	0.3	0.35	0.4	V
118	Sub-bright variable range 1-G, B	Vsbprt1, gb		21 23			0.27	0.32	0.37	V
119	Sub-bright variable range 2-R	Vsbprt2, r	SUB BRIGHT: 0	19			-0.38	-0.33	-0.28	V
120	Sub-bright variable range 2-G, B	Vsbprt2, gb		21 23			-0.36	-0.34	-0.26	V

I<sup>2</sup>C bus system items

No.	Item	Symbol	Min.	Typ.	Max.	Unit
121	High level input voltage	V <sub>ih</sub>	3.0	—	5.0	V
122	Low level input voltage	V <sub>il</sub>	0	—	1.5	V
123	High level input current	I <sub>ih</sub>	—	—	10	μA
124	Low level input current	I <sub>il</sub>	—	—	10	μA
125	Low level output voltage During current inflow of 3 mA to SDA (Pin 41)	V <sub>ol</sub>	0	—	0.4	V
126	SDA inflow current	I <sub>ol</sub>	3	—	—	mA
127	Input capacitance	C <sub>i</sub>	—	—	10	pF
128	Clock frequency	f <sub>scl</sub>	0	—	100	kHz
129	Data change minimum waiting time	t <sub>buf</sub>	4.7	—	—	μs
130	Data transfer start waiting time	t <sub>hd;sta</sub>	4.0	—	—	μs
131	Low level clock pulse width	t <sub>low</sub>	4.7	—	—	μs
132	High level clock pulse width	t <sub>high</sub>	4.0	—	—	μs
133	Start preparation waiting time	t <sub>su;sta</sub>	4.7	—	—	μs
134	Data hold time	t <sub>hd;dat</sub>	5	—	—	μs
135	Data preparation time	t <sub>su;dat</sub>	250	—	—	ns
136	Rise time	t <sub>r</sub>	—	—	300	ns
137	Fall time	t <sub>f</sub>	—	—	300	ns
138	Stop preparation waiting time	t <sub>su;sto</sub>	4.7	—	—	μs

Signals Used for Measurements

H system

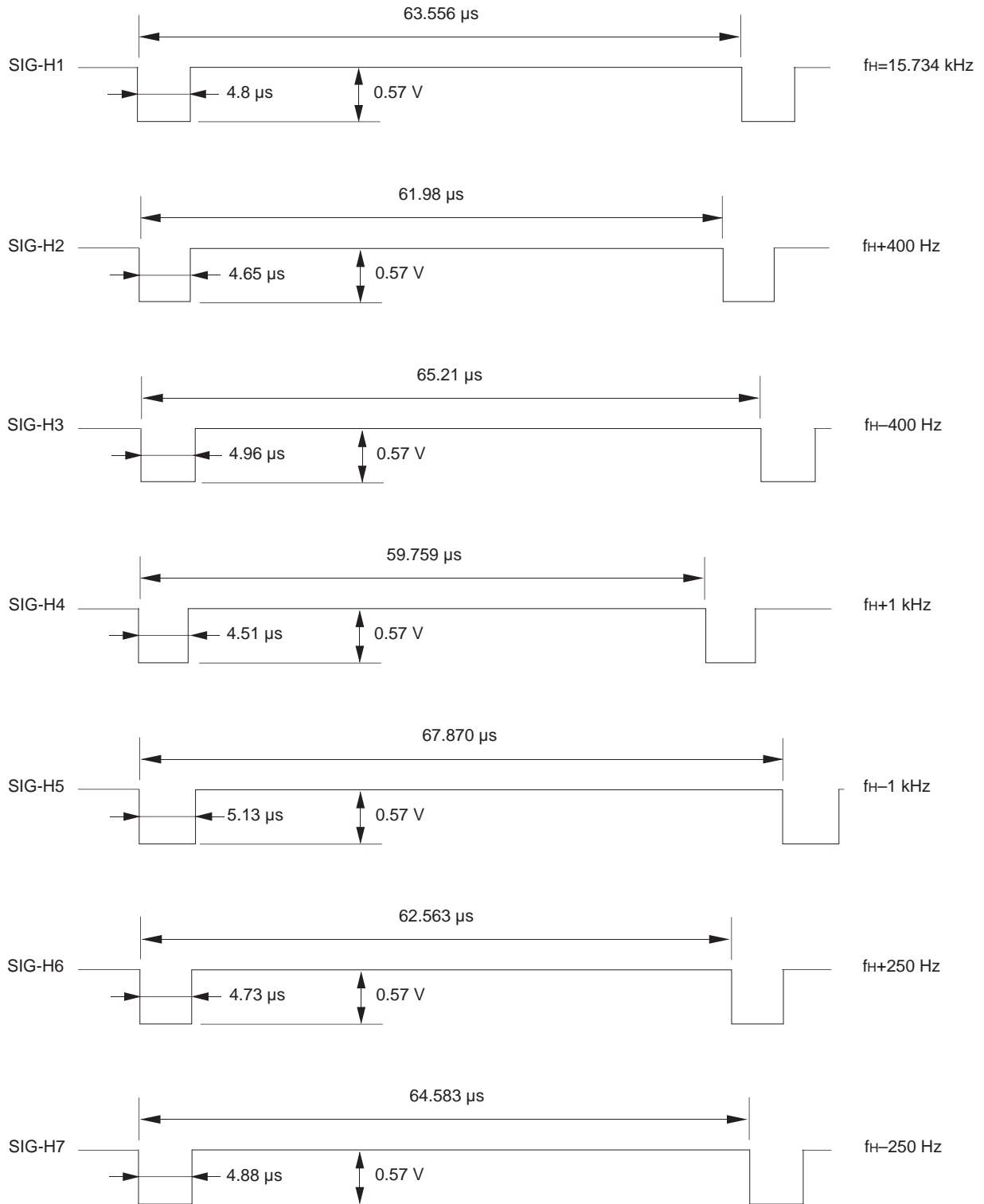

V system

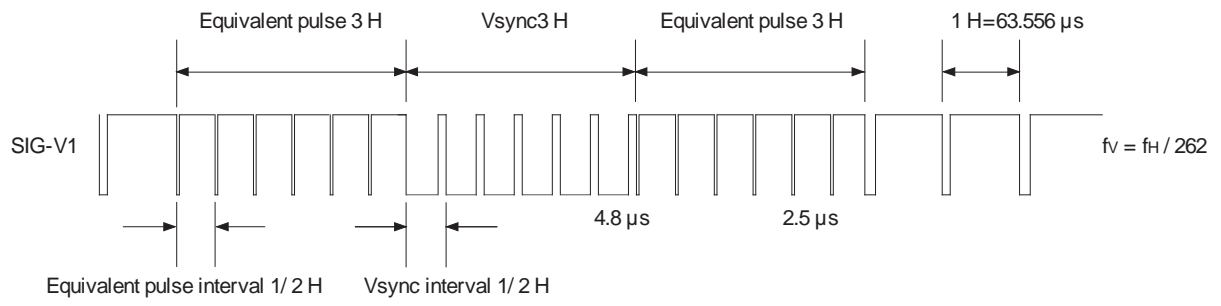

Y system

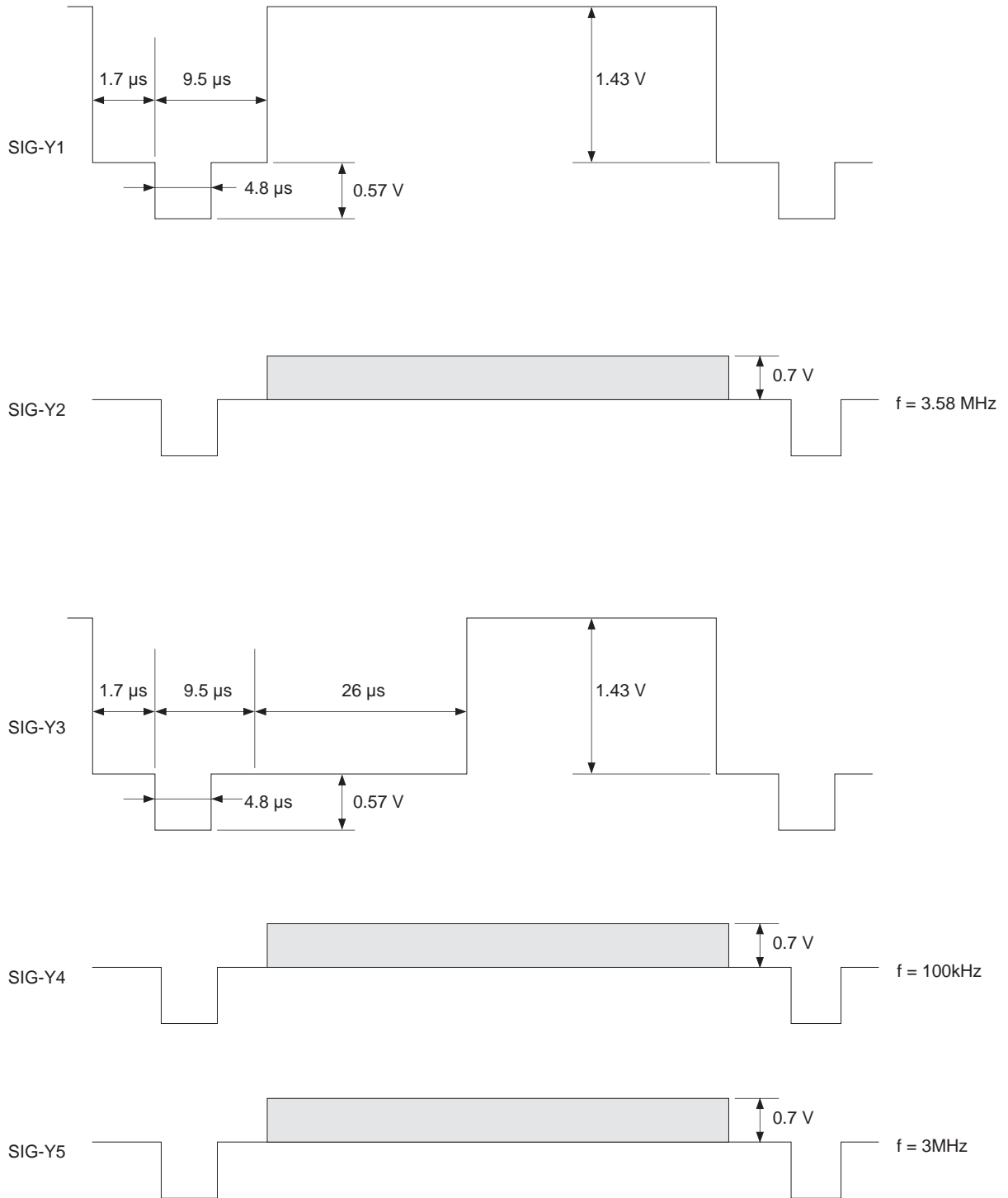

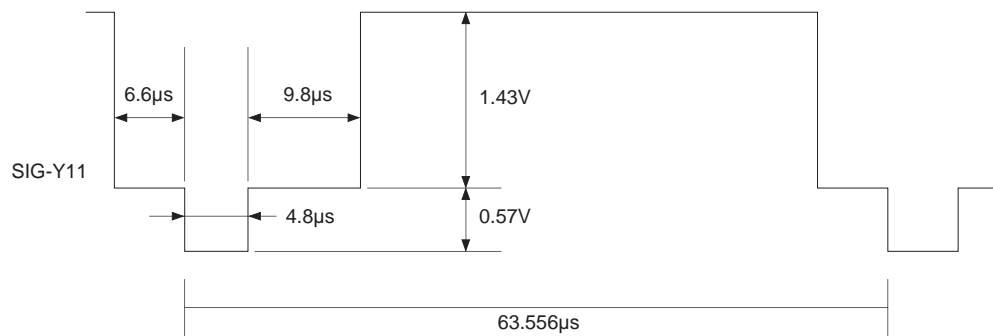
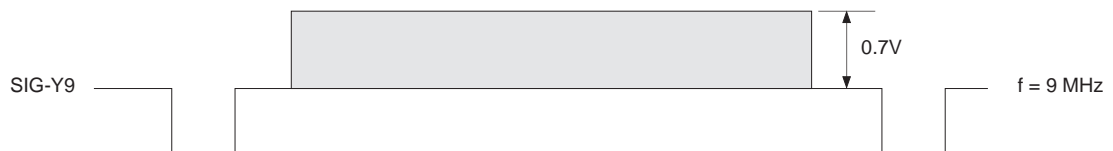
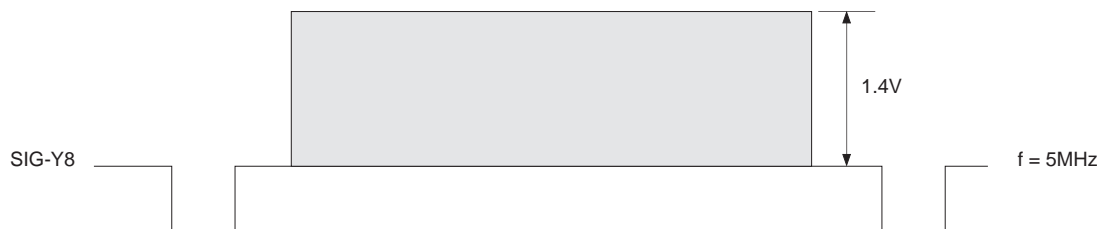
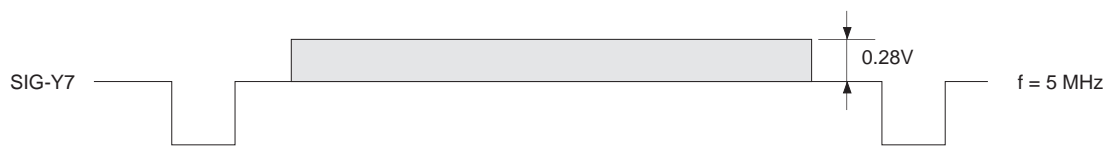
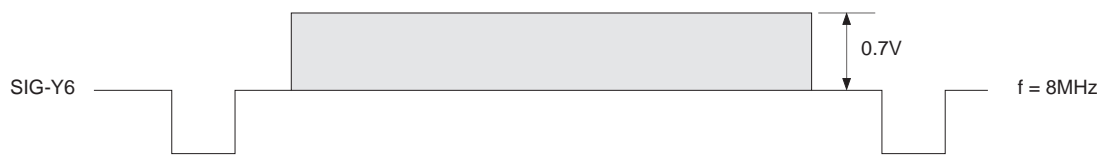

C system

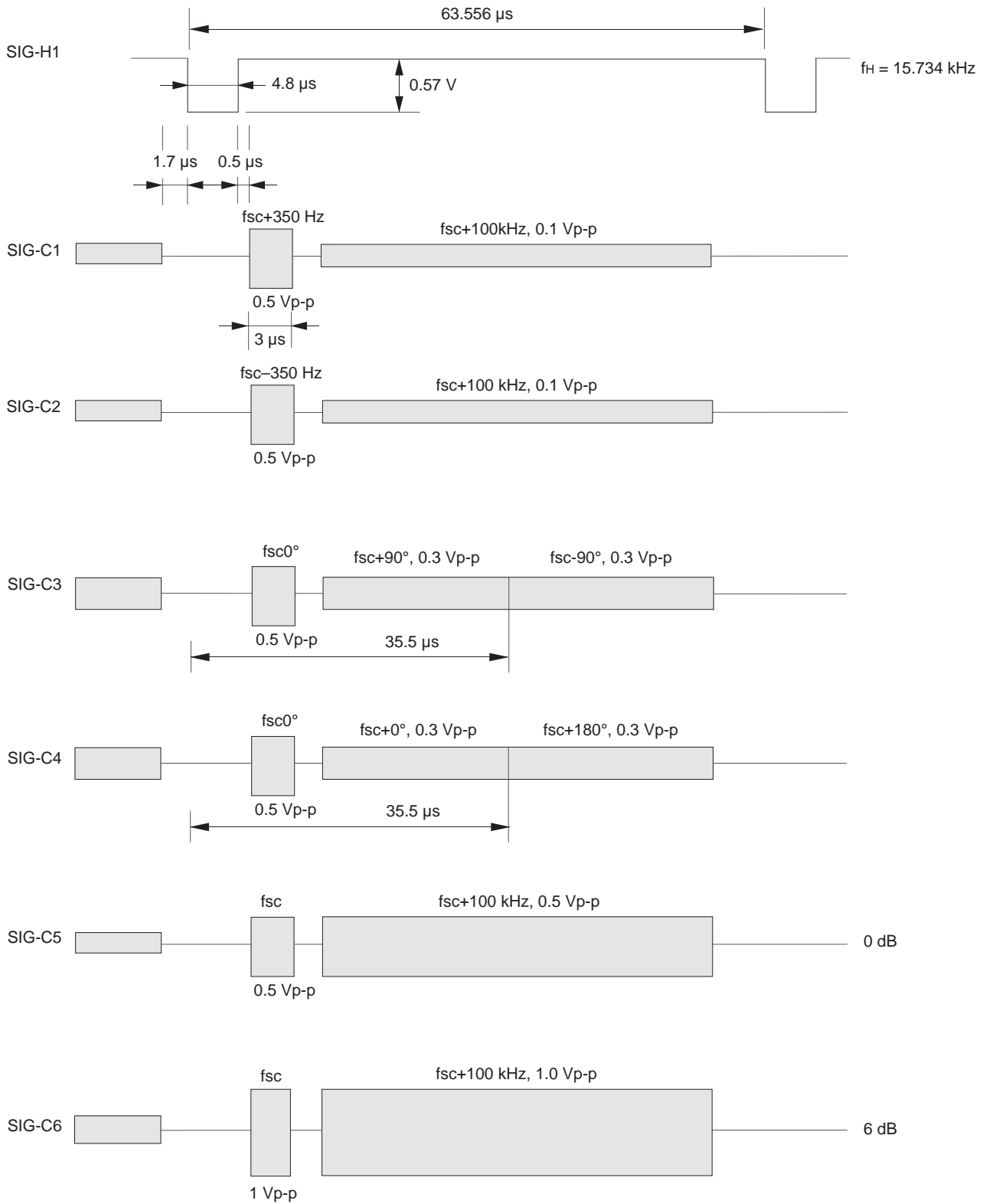



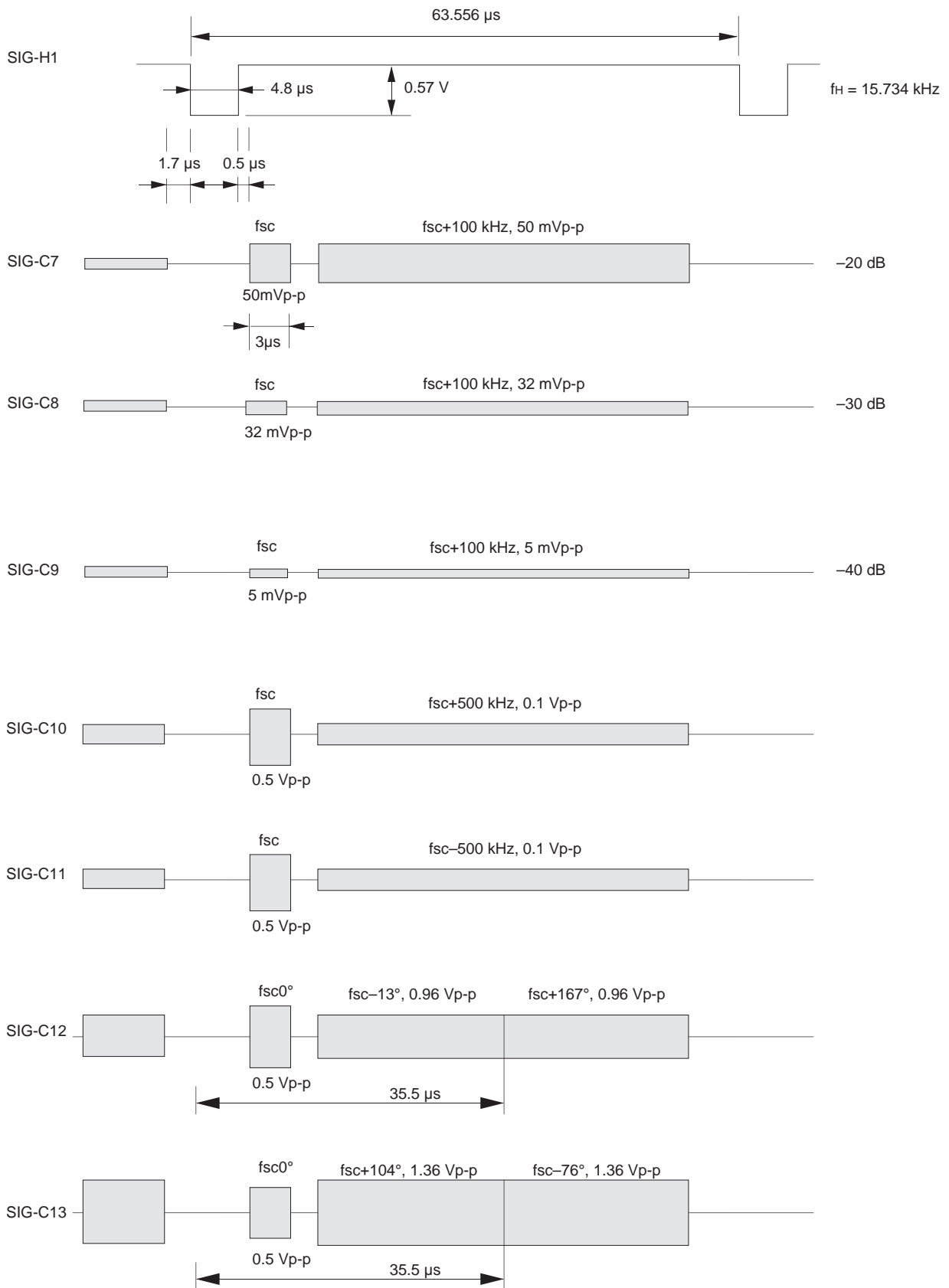

RGB system

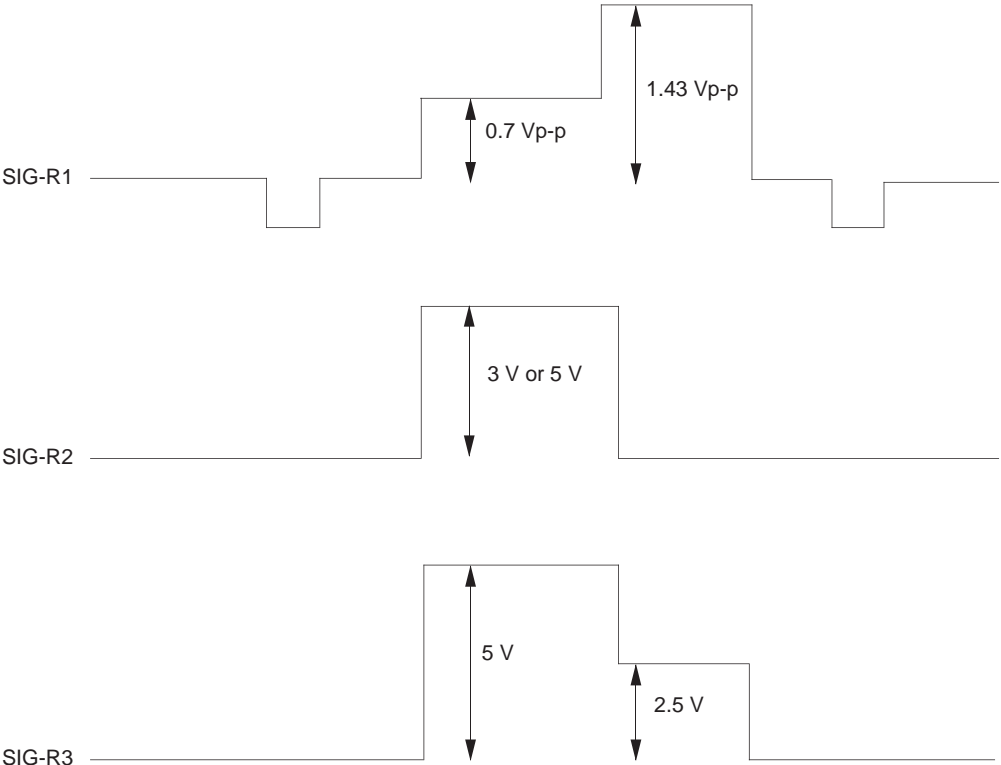

## Measurement Method

I<sup>2</sup>C Bus Register Initial Settings

Register name	No. of bits	Initial setting	Description	Register name	No. of bits	Initial setting	Description
PICTURE	6	3 FH	Maximum value	OSD	1	0 H	Luminance level small
RGB LIM	2	3 H	Maximum value	G DRIVE	5	FH	Center value
HUE	6	1 FH	Center value	DC TRAN	3	0 H	Minimum value
IN SW	1	0 H	V1 IN selected	B DRIVE	5	FH	Center value
COLOR	6	1 FH	Center value	GAMMA	3	0 H	Correction OFF
SW GAIN	1	0 H	0 dB gain	G CUTOFF	4	7 H	Center value
BRIGHT	6	1 FH	Center value	B CUTOFF	4	7 H	Center value
NR ON	1	0 H	NR OFF	H PHASE	4	7 H	Center value
SHARPNESS	4	7 H	Center value	V ON	1	1 H	VD output ON
SUB CONT	4	7 H	Center value	V EX OFF	1	1 H	V sync expansion OFF
SUB HUE	4	7 H	Center value	AFC	2	1 H	Center value
SUB COLOR	4	7 H	Center value	V SHIFT	5	FH	Center value
SUB BRIGHT	6	1 FH	Center value	HV COMP	3	3 H	Center value
TRAP ON	1	0 H	TRAP OFF	V SIZE	6	1 FH	Center value
TOT ON	1	0 H	TOT OFF	C MODE	1	0 H	Countdown ON
PIX ON	1	1 H	Picture mute OFF	V LIN	4	7 H	Center value
R ON	1	1 H	R output ON	SCORR	4	7 H	Center value
G ON	1	1 H	G output ON	SYSTEM1	1	1	Fixed mode
B ON	1	1 H	B output ON	SYSTEM2	1	0	60 Hz
PRE OVER	3	0 H	Minimum value	SYSTEM3	1	0	60 Hz
AXIS	1	0 H	NTSC detective axis	SYSTEM4	2	0	NTSC
BLACK	1	0 H	BLACK OFF	SYSTEM5	1	0	3.58 MHz
DYCOL OFF	1	1 H	DY COL OFF	X'TAL PIN	2	2	Pin 4
REF	2	1 H	Center value	DELAY	2	0	Y Delay 0ns
ABL	2	0 H	Minimum value	4.43X'TAL	1	0	3.58 MHz x'tal
BLUE	1	0 H	BLUE OFF	EXT COLOR	1	0	Identification switching

Electrical Characteristics Measurement Circuit

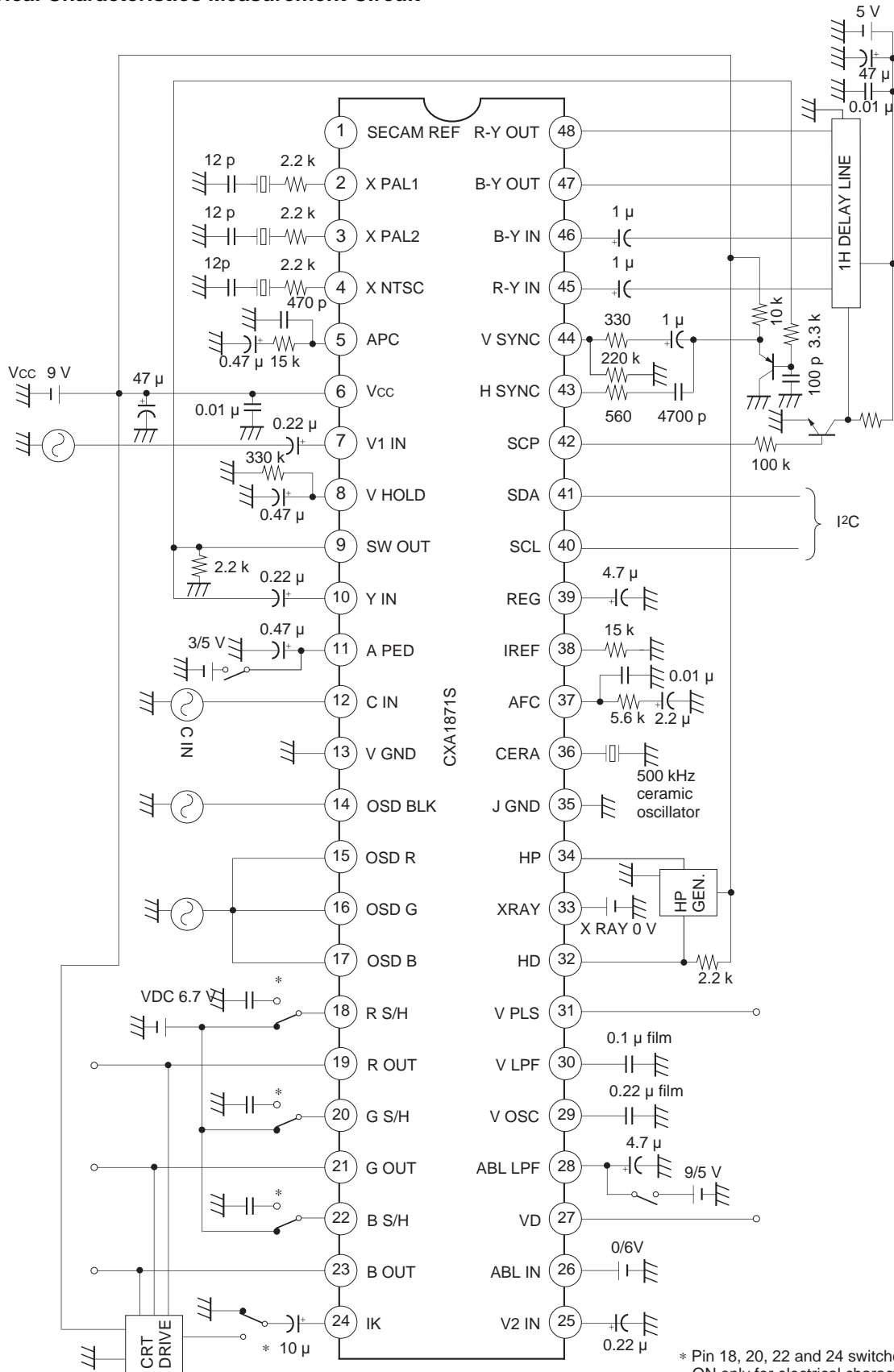

\* Pin 18, 20, 22 and 24 switches are ON only for electrical characteristic measurements No. 106 to 109.

Reference Circuit

CRT Drive Circuit

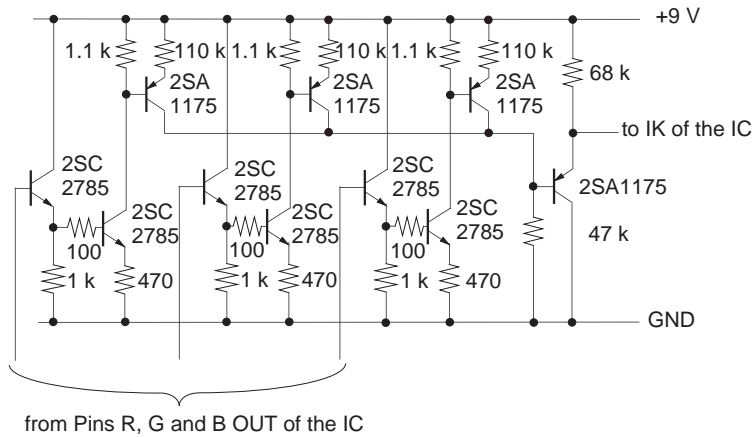

HP Gen

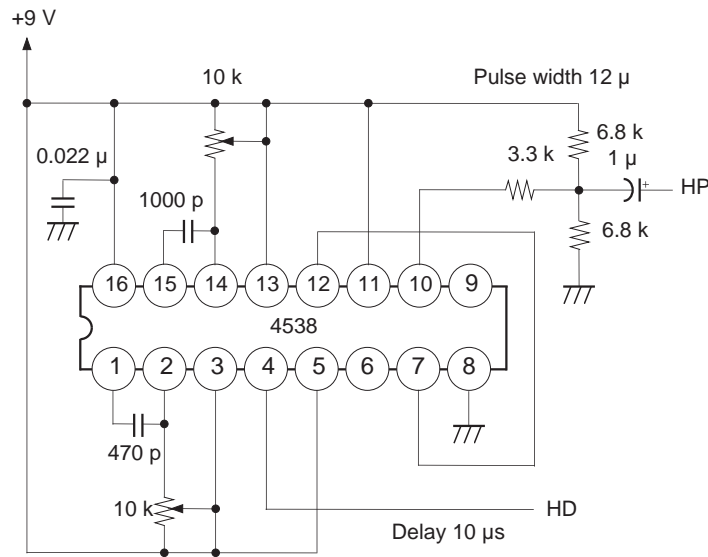

1H DELAY LINE

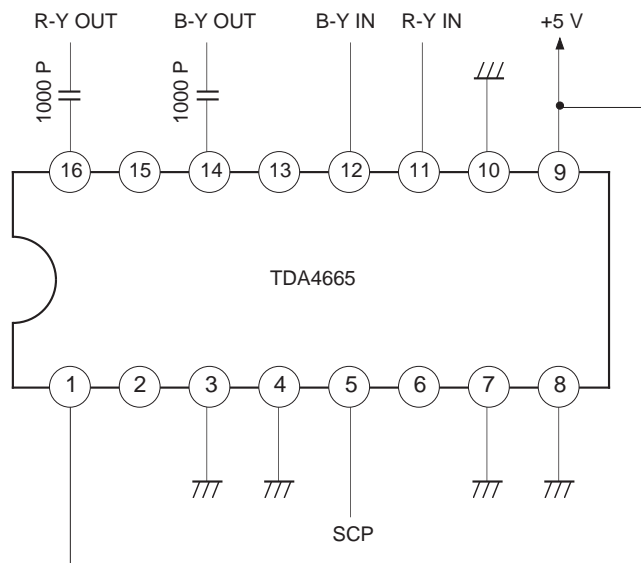

Application Circuit

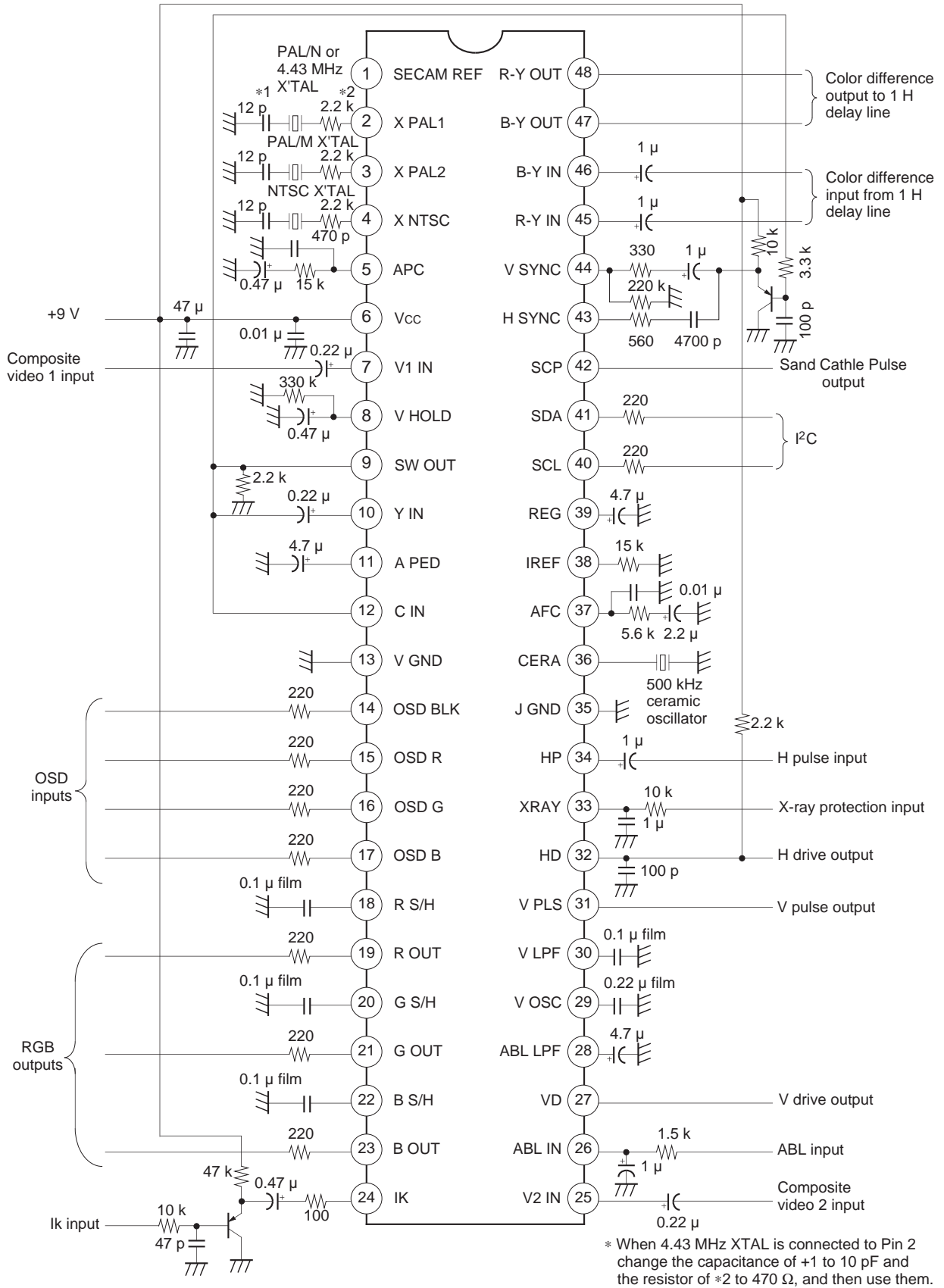

Application circuits shown are typical examples illustrating the operation of the devices. Sony cannot assume responsibility for any problems arising out of the use of these circuits or for any infringement of third party patent and other right due to same.

## Description of Operation

### 1. Synchronizing and picture distortion correction systems

The video signals (2 V<sub>p-p</sub> standard) input to Pins 43 and 44 are led to the horizontal and vertical sync separation circuits for sync separation.

This horizontal sync signal is compared with the signal obtained by 1/32 frequency dividing the 32 fh VCO output using the ceramic oscillator (frequency: 503.5 kHz) to detect a phase difference. The error voltage resulting from the phase difference is applied to the H oscillator after attenuating the medium and high frequency components by a lag-lead filter. The phase of the H oscillator output is compared and shifted to match the phase of the H deflection pulse (flyback pulse) input from Pin 34, and then output from Pin 32.

After the vertical sync signal is synchronized to the input signal by the V countdown system, a sawtooth wave is generated by charging and discharging the capacitor attached externally to Pin 29. AGC is performed to ensure that the amplitude of the sawtooth wave output is maintained constant regardless of the vertical frequency of the input, after which the sawtooth wave passes through the picture distortion correction circuit and is output from Pin 27.

Note that there is no need to adjust the free running frequency for either the H or V oscillator.

When voltage of 3 V or more is applied to Pin 33, the H drive output is held at low level. A time constant circuit is included to protect against overvoltages, and H drive is output normally when high voltage input continues for less than 7 V cycles. To release holddown, the IC must be turned off and then started up again.

BGP, HBLK and VBLK are output to Pin 42 as SCP (Sand Cathle Pulse).

### Note)

If external capacitance of Pin 30 is used with 0.1 μF or less of the recommended value, vertical sync output may be unstable.

When changing the capacitance value, use it with 0.047 μF or more.

## 2. Y/C system

The Y/C system has the following three input systems.

Composite video input (1 Vp-p/2 Vp-p) → 2 systems (The gain can be switched between 0 and 6 dB for both systems.)

Y/C separation input (2 Vp-p) → 1 system

The Y signal (specified input level 2 Vp-p) input to Pin 10 is passed through the sub-contrast control, chroma trap (or delay line), delay line, sharpness control, noise reduction, clamp and auto pedestal circuits. The signal is then mixed with the color difference signal, passed through the clamp and Y/C MIX circuits again, and input to the RGB interface system block.

Since a built-in chroma trap is provided, the video signal can be directly input. Trap frequency adjustment is not necessary as a dummy filter is provided inside the IC and feedback is applied using the 3.58 MHz or 4.43 MHz signal generated by a crystal oscillator for reference. When the chroma trap is off, the Y system frequency response is approximately 8 MHz, -3 dB for R, G and B outputs.

Sharpness control is delay line type with a variable PRE/OVER ratio.

Dynamic picture control consists of pulling in the signal below 40 IRE to the black side so that the signal black peak held by Pin 11 becomes the pedestal level.

The chroma signal (specified input level, burst 570 mVp-p, or video signal 2 Vp-p) input to Pin 12 is passed through the ACC and TOT, and the burst only is set to the maximum gain by the B.G. This burst is then peak detected by ACC DET, level controlled by the I<sup>2</sup>C bus register, and fed back to the ACC again. When the B.G. output burst signal is smaller than a certain level, killer turns on, the chroma signal is replaced with DC by the B.G., and the color gain is set to the minimum. The burst signal is detected using the VCO oscillation output which has received hue control as the carrier, and a signal (the R-Y axis sub-carrier due to chroma demodulation) whose phase is offset 90° from the burst signal is generated. During PAL input, this sub-carrier is inverted 180° every 1 H and output. The phase is not inverted during NTSC input. The chroma signal is demodulated into the color difference signals R-Y and B-Y by this sub-carrier. The signal is set to 6 dB during NTSC input, or passed through the 1 H delay line and set to 0 dB during SECAM and PAL input, after which it is input to the matrix circuit where the G-Y color difference signal is generated. Then, the color difference signals are passed through the Y/C MIX circuit, and input together with the Y signal to the RGB interface system block.

The detective axis (NTSC/PAL) can be switched by the I<sup>2</sup>C bus register.

NTSC or PAL input is automatically identified and output to the status register. In addition, during PAL input, the phase relationship between the burst and R-Y sub-carrier is detected. If a phase error is detected at this time, it is corrected by applying feedback to the flip flop.



### 3. RGB interface system

YS/YM switching is performed according to the amplitude of the OSD RGB input blanking signal input from Pin 14.

0 to 1.5 V	→	TV (Y/C input)
1.5 to 3.5 V	→	TV -6 dB
3.5 to 5.5 V	→	Black

The R, G and B signals of the Y/C system pass through the RGB switch (BLUE and BLACK ON/OFF) and receive picture control. These signals are mixed with the digital R, G and B signals (specified input level 0 to 5 V DC) input from Pins 15, 16 and 17, passed through the dynamic color, gamma correction, bright control, drive adjustment (R channel is fixed, G and B channels are variable.), cut-off adjustment (R channel is fixed, G and B channels are variable.) and auto cut-off DC level shift circuits, and then output from Pins 19, 21 and 23 as the R, G and B signals. The RGB output amplitude has a limit voltage whose setting value can be controlled with the I<sup>2</sup>C bus register. The digital R, G and B signals are mainly used for on screen display of channels, etc. and the display level can be set with the I<sup>2</sup>C bus register.

The signal input to Pin 26 (ABL IN) is compared with the internal reference voltage and is then integrated by the capacitor connected to Pin 28 (ABL LPF) for picture and brightness control. Picture ABL mode and combined picture ABL and brightness ABL mode can be switched with the I<sup>2</sup>C bus register.

#### Note)

When the digital R, G and B signals and OSDBLK signal are not used, connect Pins 14, 15, 16 and 17 to GND.

#### Auto cut-off

For white balance, drive control (gain control between R, G and B outputs) and cut-off control (black side DC level control) are involved. This IC uses the I<sup>2</sup>C bus register for drive control. For cut-off control, a loop is formed between the IC and CRT to achieve auto cut-off control.

This auto cut-off arrangement makes it possible to compensate for CRT changes with time. To absorb the CRT variance, the cut-off voltages of the G and B outputs are adjusted by the I<sup>2</sup>C bus register.

The auto cut-off loop is configured as described below.

- (1) R, G and B reference pulses for auto cut-off, shifted 1H each in the order mentioned, are added to the top of the picture.
- (2) The IK of each of the R, G and B outputs is converted to a voltage and input to Pin 24.
- (3) The voltage input to Pin 24 is compared with the reference voltage in the IC to change the DC level of the reference pulses.

The loop mentioned above determines the shift level of the R, G and B outputs and lets the capacitances connected to Pins 18, 20 and 22 hold the DC shift level during the 1 V period. If the voltage at any one of Pins 18, 20 and 22 is less than 4.2 V, the status register IK (bit 6) becomes "1". Use this information to blank the R, G and B outputs with the I<sup>2</sup>C bus register. The positions of the reference pulses can be changed by the I<sup>2</sup>C bus register.

**System Identification Method** (when 443XTAL = 0)

	fsc	fH	fV	PIN NO.	Conditions for locking the system to this pin	Conditions for releasing the lock
PAL/N	3582056 [Hz]	15625 [Hz]	50 [Hz]	Pin 2	(1) KILLER=ON (2) 50/60 identification result = 50 Hz*1	(1) KILLER=ON (2) When NT/PAL identification result changes from PAL to NTSC*2
PAL/M	3575611 [Hz]	15734 [Hz]	60 [Hz]	Pin 3	(1) KILLER=OFF	(1) KILLER=ON (2) When NT/PAL identification result changes from PAL to NTSC*2 (3) When 50/60 identification result changes from 60 to 50
NTSC	3579545 [Hz]	15734 [Hz]	60 [Hz]	Pin 4	(1) KILLER=OFF	(1) KILLER=ON (2) When 50/60 identification result changes from 60 to 50

\*1 When the 50/60 identification result changes from 60 Hz to 50 Hz, pin switching is performed until the system is locked to Pin 2. However, when the 50/60 identification result changes from 50 Hz to 60 Hz, identification is ignored.

\*2 NTSC→PAL = Don't care

**System Identification Method** (when 443XTAL = 1)

	fsc	fH	fV	PIN NO.	Conditions for locking the system to this pin	Conditions for releasing the lock
4.43/PAL	4433619 [Hz]	15625 [Hz]	50 [Hz]	Pin 2	(1) KILLER=ON (2) 50/60 identification result = 50 Hz*1	(1) KILLER=ON (2) When NT/PAL identification result changes from PAL to NTSC*2
SECAM	4406250 [Hz] 4250000 [Hz]	15625 [Hz]	50 [Hz]		(1) KILLER=ON (2) 50/60 identification result = 50 Hz*1 (3) SECAM ID=ON	(1) When any one of the conditions to the left is not met
4.43 NTSC	4433619 [Hz]	15734 [Hz]	60 [Hz]		(1) KILLER=OFF	(1) KILLER=ON
PAL/M	3575611 [Hz]	15734 [Hz]	60 [Hz]	Pin 3	(1) KILLER=OFF	(1) KILLER=ON (2) When NT/PAL identification result changes from PAL to NTSC*2 (3) When 50/60 identification result changes from 60 to 50
NTSC	3579545 [Hz]	15734 [Hz]	60 [Hz]	Pin 4	(1) KILLER=OFF	(1) KILLER=ON (2) When 50/60 identification result changes from 60 to 50

\*1 When the 50/60 identification result changes from 60 Hz to 50 Hz, pin switching is performed until the system is locked to Pin 2. However, when the 50/60 identification result changes from 50 Hz to 60 Hz, identification is ignored.

\*2 NTSC→PAL = Don't care

**Definition of I<sup>2</sup>C Bus Registers**

Slave addresses

- 88H: Slave Receiver
- 89H: Slave Transmitter

Register table

- All registers are set to 0 when the IC power is turned on.
- “X” indicates “don’t care”; “\*” indicates undefined.

Control registers

Sub Address	bit 7	bit 6	bit 5	bit 4	bit 3	bit 2	bit 1	bit 0
XXX00000	PICTURE					RGB LIM		
XXX00001	HUE					*	IN SW	
XXX00010	COLOR					*	SW GAIN	
XXX00011	BRIGHT					*	NR ON	
XXX00100	SHARPNESS				SUB CONT			
XXX00101	SUB HUE				SUB COLOR			
XXX00110	SUB BRIGHT						TRAP ON	TOT ON
XXX00111	PIX ON	R ON	G ON	B ON	PRE OVER			AXIS
XXX01000	BLACK	DY COL OFF	REF		ABL		BLUE	OSD
XXX01001	G DRIVE				DC TRAN			
XXX01010	B DRIVE				GAMMA			
XXX01011	G CUTOFF				B CUTOFF			
XXX01100	H PHASE				V ON	VEX OFF	AFC	
XXX01101	VSHIFT				HV COMP			
XXX01110	V SIZE						0	C MODE
XXX01111	V LIN				S CORR			
XXX10000	SYSTEM1	SYSTEM2	SYSTEM3	SYSTEM4		SYSTEM5	X'TAL PIN	
XXX10001	DELAY		4.43X'TAL	EXT COLOR	*	*	*	*

Status register

bit 7	bit 6	bit 5	bit 4	bit 3	bit 2	bit 1	bit0
H LOCK	IK	KILLER	XRAY	NT/PAL	50/60	VCO-F	SECAM

## Description of I<sup>2</sup>C Bus Registers

Sub Address 00000	PICTURE (6)	Picture control
	0 = Minimum	
	63 = Maximum	
	RGB LIM (2)	RGB output amplitude limiter voltage control
	0 = Limited at 4.9 V (with a black level of 2 V)	
	1 = Limited at 5.1 V (with a black level of 2 V)	
	2 = Limited at 5.3 V (with a black level of 2 V)	
	3 = Limited at 5.5 V (with a black level of 2 V)	
Sub Address 00001	HUE (6)	Hue control
	0 = Skin color nearer to red	
	63 = Skin color nearer to green	
	IN SW (1)	Input selector switch
	0 = V1 IN	
	1 = V2 IN	
Sub Address 00010	COLOR (6)	Color control
	0 = Minimum	
	63 = Maximum	
	SW GAIN (1)	SW output gain switching
	0 = SW GAIN 0dB	
	1 = SW GAIN 6dB	
Sub Address 00011	BRIGHT (6)	Brightness control
	0 = Minimum	
	63 = Maximum	
	NR ON (1)	Y signal noise reduction ON/OFF
	0 = OFF	
	1 = ON	
Sub Address 00100	SHARPNESS (4)	Sharpness control
	0 = Minimum	
	15 = Maximum	
	SUB CONT (4)	Sub-contrast control
	0 = Minimum	
	15 = Maximum	

Sub Address 00101	SUB HUE (4)      Hue center control 0 = Skin color nearer to red 15 = Skin color nearer to green
	SUB COLOR (4)    Color center control 0 = Minimum 15 = Maximum
Sub Address 00110	SUB BRIGHT (6)   Sub-bright control 0 = Minimum 63 = Maximum
	TRAP ON(1)       Chroma trap in Y system ON/OFF 0 = OFF 1 = ON
	TOT ON (1)       Chroma TOT filter ON/OFF 0 = OFF 1 = ON
Sub Address 00111	PIX ON (1)        Picture mute ON/OFF 0 = Picture mute (Auto cut-off reference pulse also muted.) 1 = Picture mute released.
	R ON (1)          R OUT ON/OFF 0 = R OUT OFF 1 = R OUT ON
	G ON (1)          G OUT ON/OFF 0 = G OUT OFF 1 = G OUT ON
	B ON (1)          B OUT ON/OFF 0 = B OUT OFF 1 = B OUT ON
	PRE OVER (3)     Sets the sharpness preshoot and overshoot ratio. 0 = Pre Shoot 100 %, Over shoot 0 % 7 = Pre Shoot 25 %, Over shoot 75 %
	AXIS(1)           Detective axis switching 0 = NTSC 1 = PAL

Sub Address 01000	BLACK (1)	Blanks the Y IN/C IN signals and sets the R, G and B outputs to black level.  0 = OFF 1 = ON
	DY COL OFF (1)	Dynamic color ON/OFF 0 = Dynamic color ON 1 = Dynamic color OFF
	REF (2)	Switches the auto cut-off reference pulse position. 0 = B-18H G-19H R-20H 1 = B-20H G-21H R-22H 2 = B-22H G-23H R-24H 3 = B-24H G-25H R-26H
	ABL (2)	ABL mode setting 0 = Picture ABL mode (including protective bright ABL) 1 = Combined picture ABL and bright ABL mode (bright ABL low) 2 = Combined picture ABL and bright ABL mode (bright ABL medium) 3 = Combined picture ABL and bright ABL mode (bright ABL high)
	BLUE (1)	On screen display B IN ON/OFF. Setting to ON turns the entire screen BLUE.  0 = OFF 1 = ON
	OSD (1)	On screen display luminance setting 0 = Level small 1 = Level large
Sub Address 01001	G DRIVE (5)	G OUT drive control 0 = Minimum 31 = Maximum
	DC TRAN (3)	DC transmission ratio setting 0 = Maximum (100 %) 7 = Minimum (75 %)
Sub Address 01010	B DRIVE (5)	B OUT drive control 0 = Minimum 31 = Maximum
	GAMMA (3)	$\gamma$ correction value setting 0 = Correction OFF 7 = Maximum correction

Sub Address 01011	G CUTOFF (4)    G OUT cut-off voltage control 0 = Minimum 15 = Maximum
	B CUTOFF (4)    B OUT cut-off voltage control 0 = Minimum 15 = Maximum
Sub Address 01100	HPHASE (4)      Horizontal position control 0 = Screen shifted to right 15 = Screen shifted to left
	V ON(1)            VD output ON/OFF 0 = VD output stopped. (Picture mute applied simultaneously. Auto cut-off reference pulse also muted.) 1 = VD output
	V EX OFF (1)      V sync expansion ON/OFF 0 = V sync expansion ON 1 = V sync expansion OFF
	AFC (2)            AFC loop gain switching 0 = AFC loop gain large 1 = AFC loop gain medium 2 = AFC loop gain small 3 = AFC loop open, free running mode
Sub Address 01101	V SHIFT (5)      Vertical position control 0 = Rise 31 = Lower
	HV COMP (3)      Vertical correction amount setting for high voltage fluctuations 0 = Correction amount minimum 7 = Correction amount maximum
Sub Address 01110	V SIZE (6)        Vertical amplitude control 0 = V size minimum 63 = V size maximum
	C MODE (1)        V countdown system mode switching 0 = Non-standard signal mode, standard signal mode and no signal mode switched automatically. 1 = Fixed to non-standard signal mode (wide V sync window mode).

Sub Address      V LIN (4)            Vertical linearity control  
01111            0 = Top of screen compressed, bottom of screen expanded.  
                  15 = Top of screen expanded, bottom of screen compressed.

                  S CORR (4)            Vertical S correction control  
                  0 = S correction amount minimum  
                  15 = S correction amount maximum



Sub Address 10000	<p>SYSTEM1(1)      Selects the internal mode switching method.</p> <p>0 = Automatic switching 1 = Fixed according to the bus data</p> <p>(When *1 is selected, the SYSTEM3 to 5 and X'TAL PIN registers below must be designated.)</p> <p>SYSTEM2 (1)      Selects the V cycle when sync cannot be obtained if automatic switching is selected by SYSTEM1.</p> <p>0 = Outputs 60 Hz pulses when sync cannot be obtained. 1 = Outputs 50 Hz pulses when sync cannot be obtained.</p> <p>SYSTEM3(1)      Selects the V cycle.</p> <p>0 = 60 Hz 1 = 50 Hz</p> <p>SYSTEM4 (2)      Inputs the input signal broadcast system.</p> <p>0 = NTSC 1 = PAL 2 = SECAM 3 = SECAM</p> <p>SYSTEM5 (1)      Selects the VCO frequency</p> <p>0 = 3.58 MHz 1 = 4.43 MHz</p> <p>X'TAL PIN (2)      Selects which of the crystals connected to the various pins to use.</p> <p>0 = Pin 2 1 = Pin 3 2 = Pin 4 3 = Pin 4</p> <p>4.43X'TAL (1)      Inputs whether the crystal connected to Pin 2 is 3.58 MHz or 4.43 MHz. (When connecting a 4.43 MHz crystal, be sure to connect it to Pin 2.)</p> <p>0 = 3.58 MHz 1 = 4.43 MHz</p> <p>EXT COLOR (1)    Forcibly switches the DET SW input to external input (R-Y IN, B-Y IN).</p> <p>0 = Switched according to the NTSC/PAL identification results 1 = External input</p>
Sub Address 10001	<p>DELAY (2)          Allows the following delay times to be added to the Y signal.</p> <p>0 = 0 ns 1 = 40 ns 2 = 80 ns 3 = 120 ns</p>

H LOCK (1) Returns whether the H oscillator of the IC and the signal input to H SYNC are locked.

0 = Not locked

1 = Locked

IK (1) Returns the AKB loop stable status by detecting the IK current.

0 = IK current stable for each of R, G and B

1 = IK current unstable

KILLER (1) Returns the color killer ON/OFF status.

0 = OFF

1 = ON

XRAY(1) Returns the X-ray protection status.

0 = OFF (X-ray protection is not functioning.)

1 = ON (X-ray protection is functioning.)

NT/PAL (1) Identifies whether the input signal is NTSC or PAL and returns the results.

0 = NTSC

1 = PAL

50/60 (1) Returns the 50/60 Hz identification results.

0 = 60 Hz

1 = 50 Hz

VCO-F (1) Detects the burst frequency of the input signal and returns the results.

0 = 3.58 MHz

1 = 4.43 MHz

SECAM (1) Identifies whether the input signal is SECAM or a different signal and returns the results.

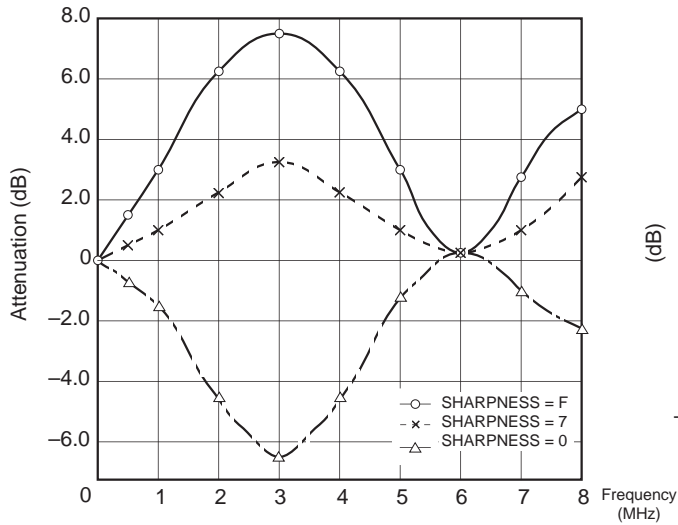

Fig 1. Sharpness characteristics

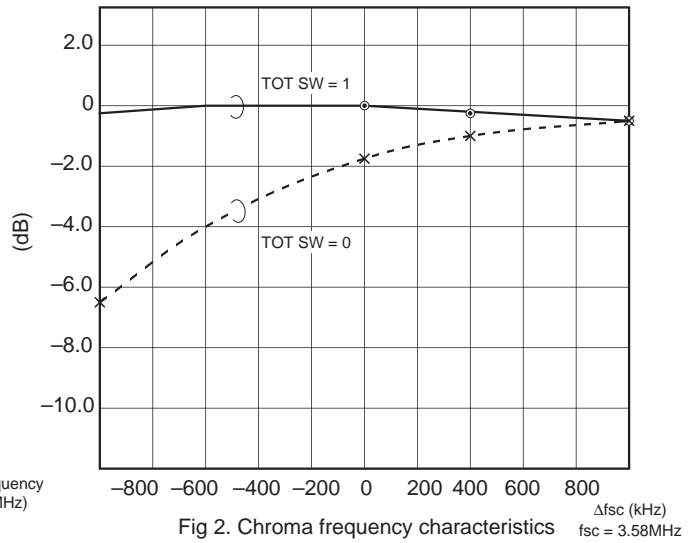

Fig 2. Chroma frequency characteristics

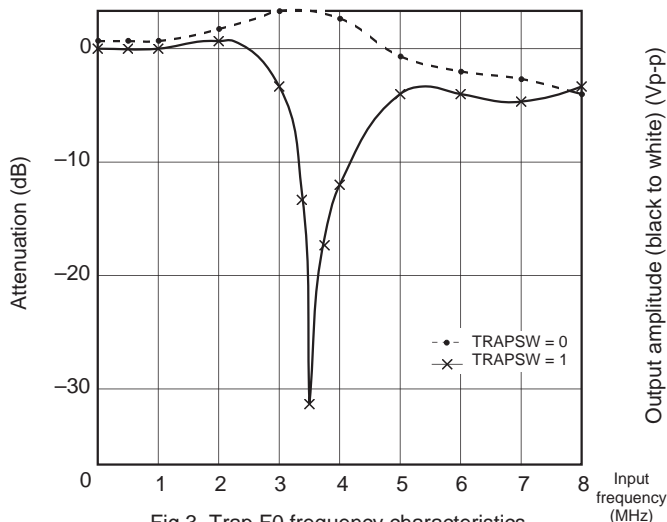

Fig 3. Trap F0 frequency characteristics

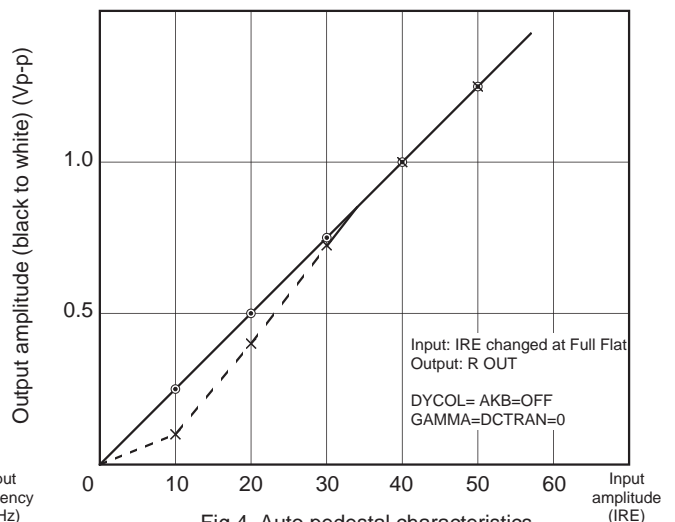

Fig 4. Auto pedestal characteristics

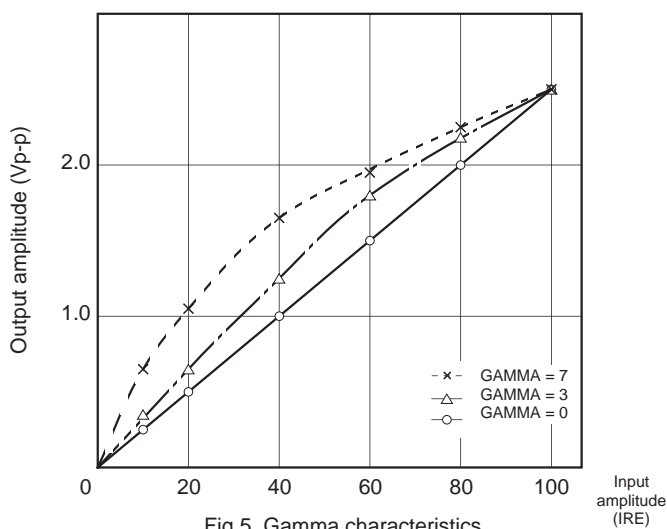

Fig 5. Gamma characteristics

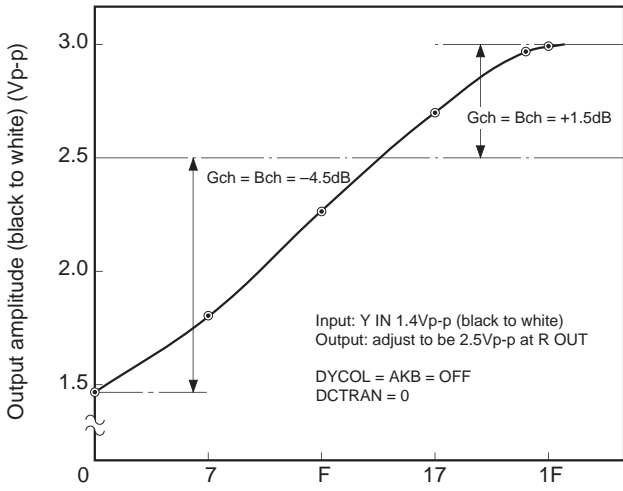

Fig 6. G, B drive characteristics

G, B  
drive data  
(HEX)

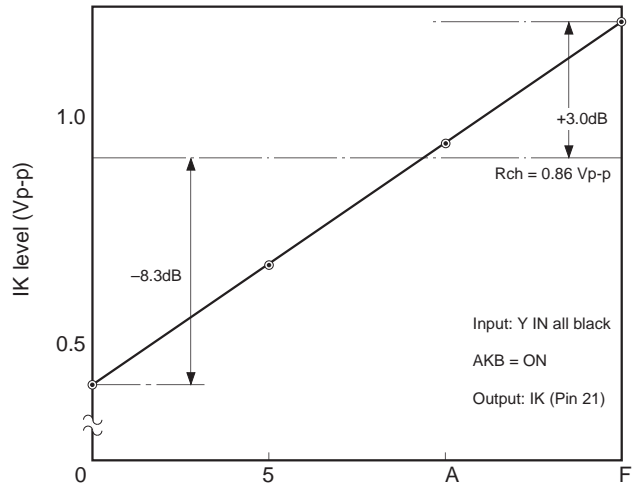

Fig 7. Cutoff control characteristics

G, B  
cutoff data  
(HEX)

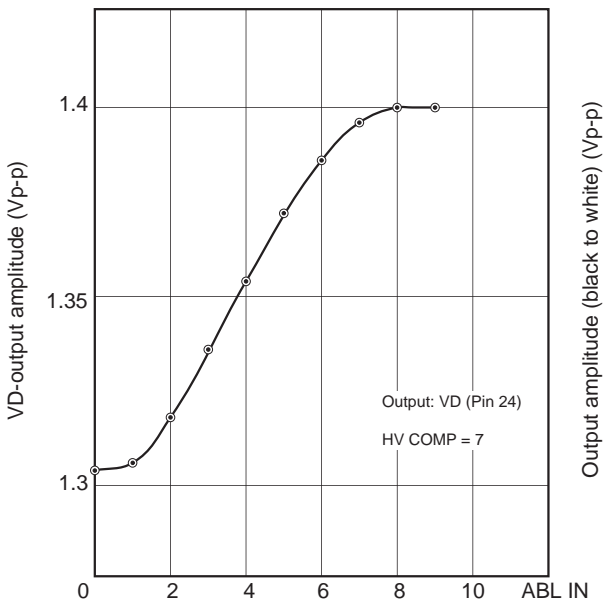

Fig 8. HV COMP characteristics

Applied  
voltage (V)

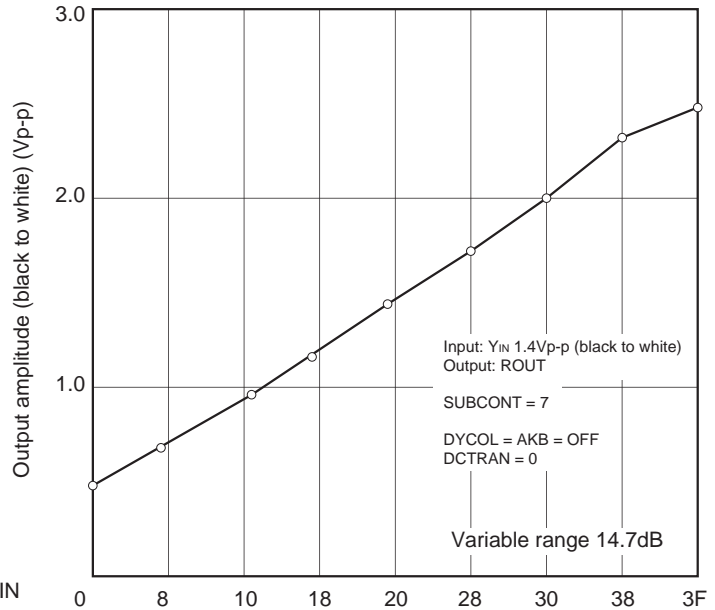
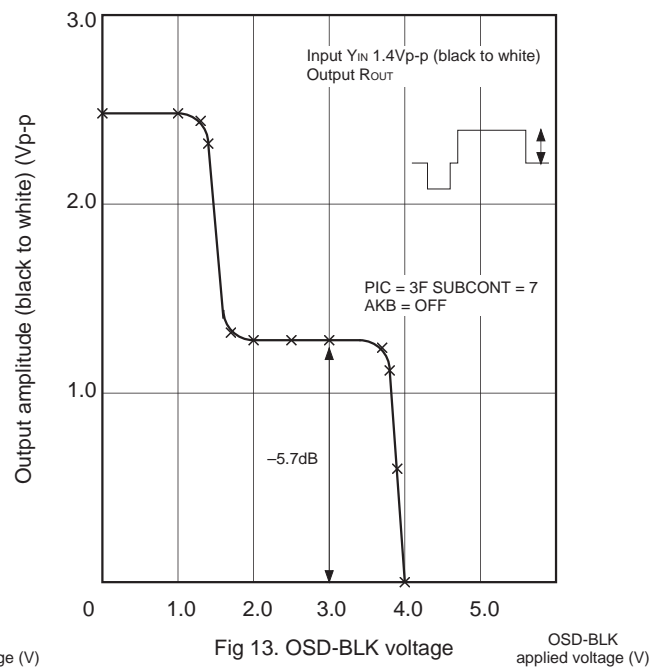
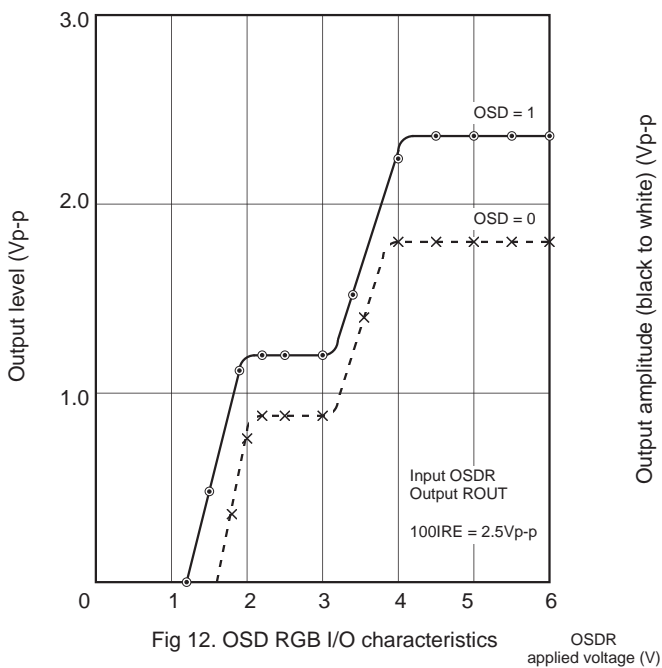
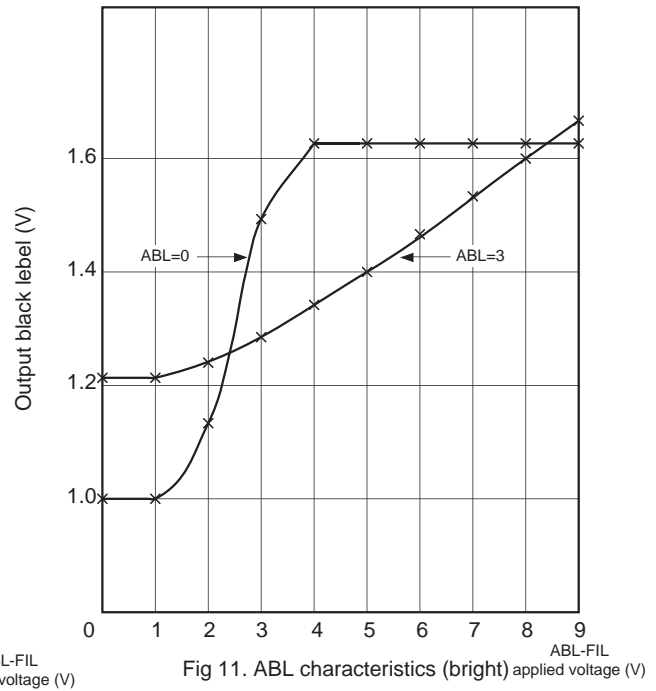
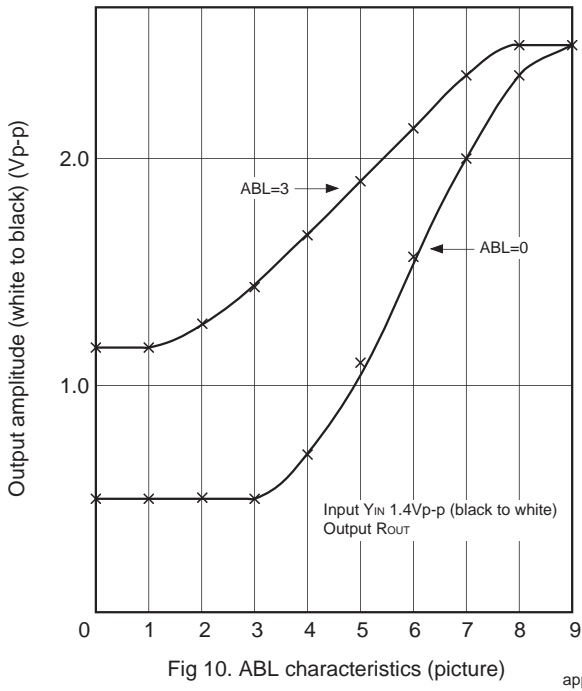
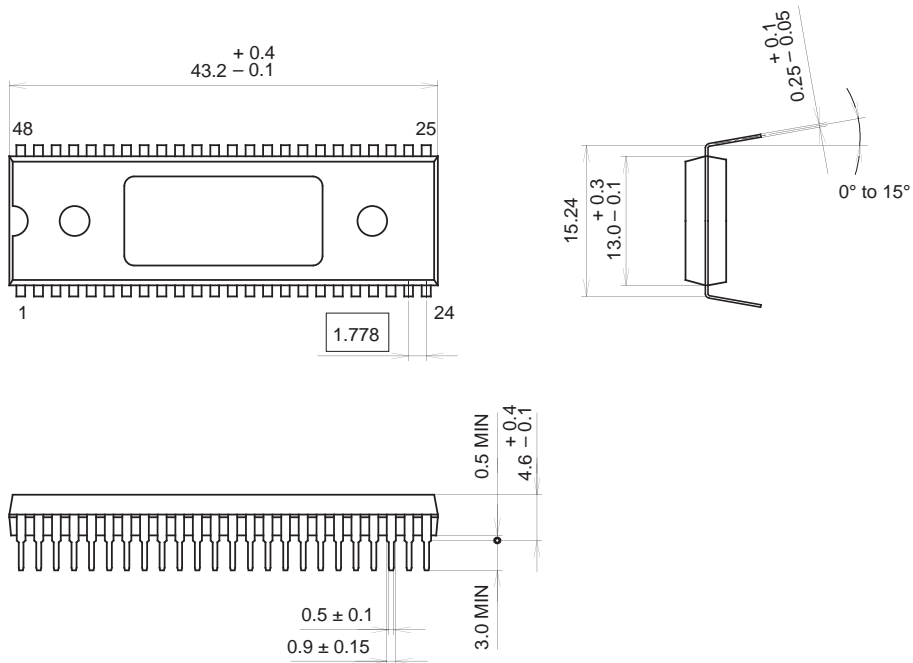

Fig 9. Picture control data (HEX)



Package Outline Unit : mm

48PIN SDIP (PLASTIC)



Two kinds of package surface:

1. All mat surface type.
2. Center part is mirror surface.

SONY CODE	SDIP-48P-02
EIAJ CODE	SDIP048-P-0600
JEDEC CODE	_____

PACKAGE STRUCTURE

PACKAGE MATERIAL	EPOXY RESIN
LEAD TREATMENT	SOLDER/PALLADIUM PLATING
LEAD MATERIAL	42/COPPER ALLOY
PACKAGE MASS	5.1g